

# ALL SOULS OF FIRE

**PELLET**  
*FR / EN*



**MCZ**

# ALL SOULS OF FIRE

---

PELLET

---

**MCZ**

# Contents

014 — 023

## CORE LA TECHNOLOGIE RÉVOLUTIONNAIRE



— THE  
REVOLUTIONARY  
CORE



006 — 007

## GAMME COMPLÈTE — FULL RANGE



132 — 163

**EASY  
TOUT CE DONT  
VOUS AVEZ BESOIN  
AU JUSTE PRIX  
— EVERYTHING  
YOU NEED  
AT THE  
RIGHT PRICE**

032 — 037

**MAESTRO+  
L'EXPÉRIENCE  
D'UTILISATION  
LA PLUS  
AVANCÉE  
— MAESTRO+  
THE MOST  
ADVANCED USER  
EXPERIENCE**



230 — 231

**QUELLE EST LA  
PREMIÈRE  
ÉNERGIE  
RENOUVE-  
LABLE ?  
— WHICH IS  
THE FIRST  
RENEWABLE  
ENERGY?**



SERGIOLEONI

214 — 229

## LES POÊLES EN CÉRAMIQUE INTEMPORELS — THE TIMELESS CERAMIC STOVES



002

MCZ PELLET

003

MCZ PELLET

# Index

004



## RONDES ROUND

AIR

- 024 Wall
- 024 Wall Angle
- 026 Loop
- 030 Berg
- 042 Halo
- 042 Halo UP! **NEW**
- 150 Hera

COMFORT AIR

- 038 Mood
- 046 Curve
- 050 Flow

HYDRO

- 106 Pad



## COULOIR SLIM

AIR

- 154 Alea

COMFORT AIR

- 054 Reflex
- 058 Ray
- 064 Doc
- 066 Stream
- 070 Philo
- 158 Raam

HYDRO

- 074 Aki
- 162 Thea

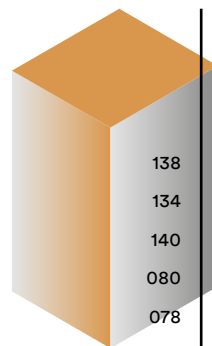

## CARRÉES SQUARE

AIR

- 138 May
- 134 Ghea **NEW**
- 140 Mida **NEW**
- 080 Tecla
- 078 Alyssa
- 082 Ego
- 088 Star **NEW**
- 092 Suite
- 096 Club
- 102 Musa **NEW**

COMFORT AIR

- 144 Teia **NEW**
- 082 Ego
- 088 Star **NEW**
- 092 Suite
- 096 Club
- 102 Musa **NEW**
- 010 Mako **NEW**

HYDRO

- 082 Ego
- 088 Star **NEW**
- 092 Suite
- 096 Club
- 102 Musa **NEW**
- 112 Jazz



## MINI

AIR

- 118 Decò
- 122 Cute

**CHOISISSEZ  
VOTRE  
FORME  
— CHOOSE  
YOUR  
SHAPE**

005

TECHNOLOGIES

- 014 Core
- 032 Maestro+
- 044 Comfort Air
- 116 Matic

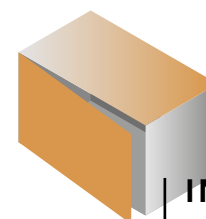

## INSERTS

AIR

- 128 Boxtherm 60
- 128 Boxtherm 70

COMFORT AIR

- 124 Vivo Maestro 90

HYDRO

- 126 Vivo Maestro 90
- Hydro

- 170 Sommaire / Summary table
- 172 Données techniques / Technical data
- 212 Légende / Key

MCZ PELLETT















MCZ PELLETT

# Gamme complète / Full range



## VERSIONS À VENTILATION FORCÉE VERSIONS WITH FORCED VENTILATION

006

 <b>WALL / WALL UP! WALL ANGLE</b> 8 kW p. 024/174	 <b>LOOP</b> 8 kW p. 026/175	 <b>BERG</b> 8 kW p. 030/176	 <b>HALO HALO UP!</b> 8 kW p. 042/177	 <b>ALYSSA</b> 6 kW p. 078/181	 <b>TECLA</b> 6 kW p. 080/182
 <b>EGO / EGO CORE EGO UP! EGO XUP!</b> 8 kW p. 082/190	 <b>STAR STAR UP!</b> 8 kW p. 088/192	 <b>SUITE / SUITE CORE SUITE UP!</b> 10 kW p. 092/194	 <b>CLUB / CLUB CORE CLUB UP!</b> 10 kW p. 096/196	 <b>MUSA MUSA CORE MUSA UP!</b> 10 kW p. 102/198	 <b>DECÒ</b> 8 kW p. 118/183
 <b>CUTE</b> 8 kW p. 122/184	 <b>BOXTHERM MAESTRO 60 / 70</b> 6 kW/8,8 kW p. 128/173				

MCZ PELLETT

 <b>HERA HERA XUP!</b> 7 kW p. 150/187	 <b>MAY</b> 7 kW p. 138/184	 <b>GHEA GHEA XUP!</b> 6 kW p. 134/185	 <b>MIDA MIDA XUP!</b> 8 kW p. 140/185	 <b>ALEA ALEA XUP!</b> 7 kW p. 154/187	<b>EASY P.132</b>
--	---	--	--	--	-------------------



## VERSIONS HYDRO HYDRO VERSIONS

 <b>AKI</b> 18/24 kW p. 074/181	 <b>EGO HYDRO MATIC</b> 12 kW p. 082/190	 <b>STAR HYDRO MATIC</b> 12 kW p. 088/192	 <b>SUITE HYDRO MATIC</b> 18/24 kW p. 092/194	 <b>CLUB HYDRO MATIC</b> 18/24 kW p. 096/196	 <b>MUSA HYDRO MATIC</b> 18/24 kW p. 102/198
---	--	---	---	--	--



## VERSIONS À AIR CANALISÉ DUCTED AIR VERSIONS

007

 <b>MAKO</b> 8 kW p. 010/174	 <b>MOOD</b> 8 kW p. 038/176	 <b>CURVE</b> 8 kW p. 046/177	 <b>FLOW</b> 10 kW p. 050/178	 <b>REFLEX</b> 8 kW p. 054/178	 <b>RAY / RAY UP! RAY UP!</b> 8 kW p. 058/179
 <b>DOC DOC UP!</b> 9 kW p. 064/179	 <b>STREAM STREAM UP!</b> 12 kW p. 066/180	 <b>PHILO PHILO UP!</b> 14 kW p. 070/180	 <b>EGO / EGO CORE EGO UP!</b> 10 kW p. 082/190	 <b>STAR STAR UP!</b> 10 kW p. 088/192	 <b>SUITE SUITE UP!</b> 12 kW p. 092/194
 <b>CLUB CLUB UP!</b> 12 kW p. 096/196	 <b>MUSA MUSA UP!</b> 12/14 kW p. 102/198	 <b>TEIA TEIA UP!</b> 10 kW p. 144/186	 <b>RAAM / RAAM UP! RAAM XUP!</b> 8 kW p. 158/188	<b>EASY P.132</b>	 <b>VIVO MAESTRO 90</b> 9/11 kW p. 124/169

MCZ PELLETT

 <b>CLIO</b> 16/23 kW p. 148/186	 <b>THEA</b> 16/23kW p. 162/188	<b>EASY P.132</b>	 <b>VIVO MAESTRO 90 HYDRO</b> 16 kW / 24 kW p. 126/171
--	---	-------------------	--

# UN MEILLEUR PRODUIT — AN IMPROVED PRODUCT

Pour chaque produit, veuillez vérifier les caractéristiques spécifiques  
— Please verify the specific features foreseen for each product

1

Allumage en 3 minutes  
— Starting in 3 minutes



2

Ventilation désactivable  
— Excludable ventilation



3

Système de gestion intelligente de la combustion  
— Intelligent system for combustion management



4

Possibilité d'installation avec évacuation supérieure ou à l'arrière  
— Possibility of installation with top or rear outlet



5

Conduit d'évacuation de fumées coaxial  
— Coaxial smoke outlet



6

Flamme silencieuse et avec mouvement naturel  
— Silent flame with natural movement



7

Vidage des cendres hebdomadaire  
— Weekly ash emptying



8

Motoréducteurs sans balais à haut rendement  
— High efficiency Brushless gear motors



9

Gestion e configuration à distance  
— Remote management and programming



10

Structure étanche  
— Hermetic structure



Mako

MINIMALISTE  
— MINIMAL

010

MCZ PELLET — MAKO Comfort Air Matic 8 Core



011

MCZ PELLET — MAKO Comfort Air Matic 8 Core

# Mako



**FR** — Poêle à pellets sans bouches frontales, entièrement réalisé en acier peint couleur Black et Bronze. Nouvelle technologie Core caractérisée par une large flamme naturelle et par des niveaux d'émission parmi les plus bas de la catégorie ; foyer beau même lorsqu'il est éteint. Brasier autonettoyant en acier inox avec vidage des cendres hebdomadaire. Bougie de préchauffage en céramique garantissant des temps d'allumage réduits de 40 %. Possibilité de désactiver totalement la ventilation. Il est possible de gérer ce poêle via un tableau de commande escamotable, une télécommande autonome avec un thermostat d'ambiance (en option) ou bien via un smartphone (WI-FI ; Bluetooth), en étant aussi bien chez soi qu'à l'extérieur.

**EN** — Pellet stove with no front vents, made entirely in Black and Bronze painted steel. New Core technology featuring a wide natural flame and one of the category's lowest emission levels. The firebox is pleasing to the eye even when it is off. Self-cleaning brazier in stainless steel with weekly ash emptying. Ceramic glow plug ensuring ignition times reduced by 40%. Option of turning ventilation off completely. This stove can be managed via a retractable control panel, freestanding remote control with room thermostat (optional) or from a smartphone (WI-FI; Bluetooth), at home as well as away.

→ Technical data p.174  
 En savoir plus sur la technologie:  
 Find out more about the technology:  
**CORE** p.014  
**MAESTRO+** p.032





core

LA  
TECHNOLOGIE  
RÉVOLUTIONNAIRE  
CORE  
— THE  
REVOLUTIONARY  
CORE  
TECHNOLOGY



LE NOUVEAU  
FOYER À  
TECHNOLOGIE  
BREVETÉE,  
UNE FLAMME  
SEMBLABLE  
À CELLE DES  
PRODUITS  
À BOIS  
QUI RESTE  
NATURELLE À  
TOUTES LES  
PUISSANCES,  
DES NIVEAUX  
D'ÉMISSIONS  
PARMI LES PLUS  
BAS DU MARCHÉ,  
UN FOYER BEAU  
À VOIR AUSSI  
BIEN ALLUMÉ  
QU'ÉTEINT



— PELLET CORE \*

\*  
Disponible pour les modèles / Available for the models:  
Mako, Suite Air, Club Air, Musa Air, Ego Air, Ego Comfort Air



— WOOD

THE NEW  
FIREBOX WITH  
PATENTED  
TECHNOLOGY,  
A FLAME  
SIMILAR TO  
WOOD-FIRED  
PRODUCTS  
THAT REMAINS  
NATURAL AT  
ALL POWER  
OUTPUTS,  
SOME OF THE  
MARKET'S  
LOWEST  
EMISSION  
LEVELS, A  
FIREBOX THAT  
IS PLEASING TO  
THE EYE EITHER  
ON OR OFF

core

LE SILENCE  
EST UN LUXE,  
OFFREZ-LE-VOUS  
— SILENCE  
IS A LUXURY,  
TREAT  
YOURSELF

018

MCZ PELLETT — CORE



1



FR — Entraîné par un moteur sans balais, le pellet alimente la combustion sans contact avec les parois métalliques, ce qui rend le fonctionnement du poêle encore plus silencieux.  
EN — Operated by a brushless motor, pellets feed combustion without touching the metal walls, which makes the operation of the stove even quieter.

2



FR — La technologie Core rend le fonctionnement du poêle encore plus silencieux, même en mode Comfort, Overnight ou Silent.  
EN — Technology Core makes stove operation even more noiseless, also in Comfort, Overnight or Silent mode.

3



FR — Grâce à une vitesse d'extraction des fumées très faible, la ventilation est presque imperceptible.  
EN — Thanks to its very low smoke extraction speed, ventilation is almost imperceptible.



019

MCZ PELLETT — CORE

NIVEAUX  
D'ÉMISSION  
PARMI LES  
PLUS BAS DE  
LA CATÉGORIE

FR — En moins par rapport  
aux limites les plus strictes  
au niveau européen  
(AriaPulita 5\*).

EN — Less compared to  
the strictest  
European limits  
(AriaPulita 5\*)

-40%  
CORE

ONE OF THE  
CATEGORY'S  
LOWEST  
EMISSION  
LEVELS

FR — En moins par rapport aux  
limites européennes d'Ecodesign.  
EN — Less compared to the  
European Ecodesign limits.

-55%  
CORE

020

021

MCZ PELLET — CORE

MCZ PELLET — CORE

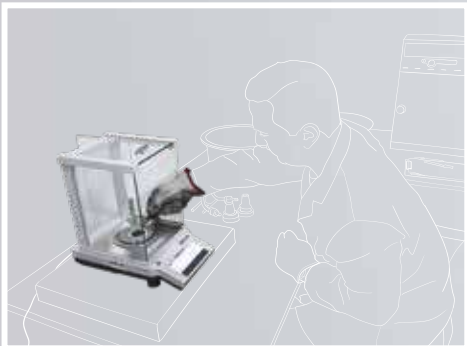
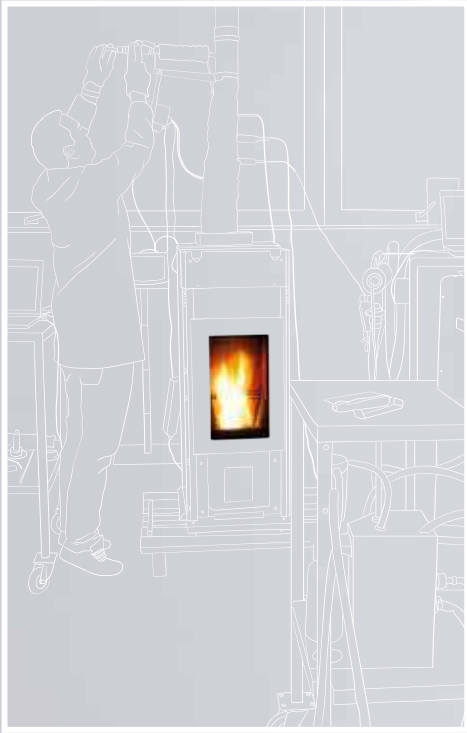

FR — Membranes  
de prélèvement des  
particules fines par  
méthode gravimétrique.  
EN — Membranes for  
particulate collection  
with gravimetric method.

10069  
Petri Dish







# COMPARAISON DE LA TECHNOLOGIE CORE — THE CORE TECHNOLOGY COMPARED

## PRODUITS TRADITIONNELS PRÉSENTS SUR LE MARCHÉ — TRADITIONAL PRODUCTS ON THE MARKET









CORE

### Performances / Performance

	TRADITIONNEL / TRADITIONAL	ÉVOLUÉE, À GAZÉIFICATION / ADVANCED, WITH GASIFICATION
 <b>Type de combustion</b> Combustion type		
 <b>Classification Aria Pulita (limites les plus strictes au niveau européen)</b> Aria Pulita classification (strictest European limits)	5* / 4*	5*
 <b>Poussières / Particulate – mg/m3 (13% O<sub>2</sub>)</b>	< 15 / < 20	9 (8 kW / 10 kW)
 <b>NOx – mg/m3 (13% O<sub>2</sub>)</b>	< 100 / < 160	95 (8 kW) / 89 (10 kW)
 <b>CO – mg/m3 (13% O<sub>2</sub>)</b>	< 250 / < 250	76 (8 kW) / 113 (10 kW)
 <b>Performances toujours élevées, même à basse puissance</b> Always high performance, even at low power		•
 <b>Production de cendres réduite</b> Low ash production		•

### Aspects visuels et confort / Visual aspects and comfort

 <b>Beauté de la flamme, fluide et propre</b> Beauty of the flame, slow and clean	NERVEUSE, PARFOIS INSTABLE FICKLE, SOMETIMES UNSTABLE	FLUIDE ET STABLE SLOW AND STABLE
 <b>Nettoyage de la vitre</b> Glass cleaning	À EFFECTUER FRÉQUEMMENT TO BE CARRIED OUT FREQUENTLY	LONGUE DURÉE LONG-LASTING
 <b>Design de la chambre de combustion</b> Combustion chamber design	TRADITIONNEL / TRADITIONAL	MINIMALISTE ET SOIGNÉ / MINIMAL AND NEAT
 <b>Brasier</b> Brazier	FONTE, APPARENT / CAST IRON, VISIBLE	INOX 304, CACHÉ / INOX 304, CONCEALED
 <b>Chute de la cendre</b> Ash dropping	VISIBLE / VISIBLE	CACHÉE / CONCEALED
 <b>Auto-nettoyage du brasier de série</b> Self-cleaning brazier supplied as standard		•

# Wall · Wall Angle

design Patricia Urquiola

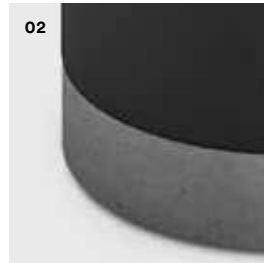

- 01 — Terrazzo
- 02 — Beton grey
- 03 — Wood
- 04 — Black
- 05 — Stone

**FR** — Poêle à pellets sans bouches frontales réalisé en acier noir avec grilles disponible en différentes finitions (Black, Stone, Terrazzo, Beton grey, Wood). La conception particulière de la structure placée contre le mur cache les éléments techniques de raccordement du poêle, contribuant ainsi à un design extrêmement précis. Une version de forme ronde pour installations d'angle est également disponible. Possibilité de désactiver totalement la ventilation. Produit équipé d'une bougie de préchauffage en céramique qui garantit une réduction des temps d'allumage de 40 %. Évacuation arrière ou supérieure. Ce produit offre plusieurs options d'utilisation. On peut choisir d'utiliser son smartphone, à la maison et à l'extérieur, ou de gérer le poêle à la maison via la télécommande « freestanding » avec thermostat d'ambiance (en option) ou le panneau de contrôle (en option).

**EN** — Pellet stove without front outlets made of black steel with base available in different finishes (Black, Stone, Terrazzo, Beton grey, Wood). The unique design of the structure that is placed against the wall hides the technical connection elements of the stove, thereby giving it an ultra-clean look. A round version is also available for corner applications. Possibility to totally exclude the ventilation. Product equipped with ceramic glow plug ensuring ignition times reduced by 40%. Rear or top outlet. This product offers several application options. You can choose to use your smartphone, both when at home and away, or to control the stove at home with the (optional) freestanding remote control with room thermostat or the (optional) control panel.

→ Technical data p.174



Loop



## Loop



**FR** — Poêle à pellets particulièrement indiqué pour une installation d'angle. Réalisé avec couvercle et panneau frontal en fonte, revêtement en acier de couleur Black ou Silver. Ouverture du couvercle par coulissement pour le chargement des pellets. Possibilité de désactiver totalement la ventilation. Produit équipé d'une bougie de préchauffage en céramique qui garantit une réduction des temps d'allumage de 40 %. Il est possible de gérer ce poêle via un tableau de commande escamotable, une télécommande autonome avec un thermostat d'ambiance (en option) ou bien via un smartphone (WI-FI ; Bluetooth), en étant aussi bien chez soi qu'à l'extérieur.

**EN** — Pellet stove particularly suitable for installation in a corner. Made with cast iron top and front, Black or Silver steel cladding. Slide-opening top for pallet loading. Possibility to totally exclude the ventilation. Product equipped with ceramic spark plug ensuring ignition times reduced by 40%. This stove can be managed via a retractable control panel, freestanding remote control with room thermostat (optional) or from a smartphone (WI-FI; Bluetooth), at home as well as away.

→ Technical data p.175

En savoir plus sur la technologie:

Find out more about the technology:

**MAESTRO** p.032





## Berg



**FR** — Poêle à pellets sans bouches frontales. En plus de la caractéristique grilles de la pierre, d'accumuler et dégager lentement la chaleur, la ventilation forcée permet de chauffer le milieu très rapidement. Possibilité de désactiver totalement la ventilation. Produit équipé d'une bougie de préchauffage en céramique garantissant des temps d'allumage réduits de 40 %. Possibilité de choisir entre la possibilité d'utiliser une télécommande palmaire (en option), un panneau de commande (en option).

**EN** — Pellet stove without front vents. In addition to the natural property of the stone to store and release heat slowly, it has forced ventilation, therefore the room can be heated up quickly. Possibility to totally exclude the ventilation. Product equipped with ceramic glow plug ensuring ignition times reduced by 40%. This product offers several application options. You can choose to use your smartphone, both when at home and away, or to control the stove at home with the (optional) freestanding remote control with room thermostat or the (optional).

→ Technical data p.176



MAESTRO+  
L'EXPÉRIENCE  
D'UTILISATION  
LA PLUS  
AVANCÉE  
— MAESTRO+  
THE MOST  
ADVANCED  
USER  
EXPERIENCE



**FR — DOUBLE CONNEXION  
(WI-FI ET BLUETOOTH) INCLUSE.**

Tout ce dont vous avez besoin pour utiliser le poêle à partir de votre smartphone est déjà inclus, que vous soyez à la maison ou à distance avec Maestro+, sans besoin de kits supplémentaires.

**EN — DUAL CONNECTION  
(WI-FI AND BLUETOOTH)  
INCLUDED.**

Everything you need to use the stove from your smartphone is already included, either at home or remotely Maestro+, without additional kits.



**FR — FLAMME PARFAITE**

La combustion avec Maestro+ est optimisée, elle génère moins de cendres et laisse la vitre propre. Il en résulte des consommations plus réduites, des émissions plus faibles et des nettoyages beaucoup moins fréquents.

**EN — PERFECT FLAME**

The combustion with Maestro is optimal, it generates less ash and leaves the glass clean. This results in lower consumptions, lower emissions and much less frequent cleanings.



**FR — PLUS D'OPTIONS  
D'UTILISATION**

Les poêles Maestro s'adaptent à votre style d'utilisation. Hors de chez vous, vous pouvez utiliser votre smartphone (WI-FI), tandis qu'à la maison, vous pouvez gérer le poêle au moyen du panneau de commande escamotable, de votre smartphone (via Bluetooth) ou de la télécommande (en option)

**EN — MORE USER OPTIONS**

Maestro stoves adapt to your style of use. When not at home you can use your smartphone (WI-FI), at home you can control the stove via the concealed control panel, smartphone (via Bluetooth) or remote control (optional).



**FR — MISE À JOUR  
AUTOMATIQUE DU  
MICROLOGICIEL À  
DISTANCE (pour les poêles  
connectées en WI-FI).**

**EN — AUTOMATIC REMOTE  
FIRMWARE UPDATE (for WI-  
FI connected stoves).**



**FR — DIAGNOSTIC ET  
ASSISTANCE À DISTANCE**

(sauf pour les interventions qui exigent la présence physique d'un technicien).

**EN — REMOTE DIAGNOSTICS AND  
ASSISTANCE (except operations  
that require a technician to be  
physically present).**

# MODES D'UTILISATION — STOVE CONTROL MODES

034

MCZ PELLETT — MAESTRO+

1

**FR — PANNEAU NUMÉRIQUE**  
Si vous êtes habitué à un usage plus traditionnel, toutes les fonctions de l'appli Maestro sont également disponibles via un panneau numérique en option, installé sur le poêle et déjà paramétré.

**EN — DIGITAL PANEL**  
If you are used to a more traditional use, all the functions of the Maestro App are also available in an optional digital panel (optional) which is already mounted on the heater and configured.



2

**FR — APP**  
Pour contrôler le poêle à distance aussi bien à la maison qu'à l'extérieur.

**EN — APP**  
To control your stove remotely both when you are at home and when you are out.

3

**FR — TÉLÉCOMMANDE FREESTANDING**  
Télécommande avec thermostat d'ambiance pour un contrôle de la température ambiante, toujours visible grâce à l'écran e-ink (en option).

**EN — FREESTANDING REMOTE CONTROL**  
Remote control with ambient thermostat for room temperature control, always visible thanks to the e-ink display (optional).



035

MCZ PELLETT — MAESTRO+

**FR** — Grâce aux 5 pré-réglages\* de l'application Maestro (Comfort, Overnight, Power, Dynamic, Manual), la gestion du poêle est désormais encore plus facile, la consommation de combustible est optimisée et le confort d'utilisation est amélioré, permettant d'assurer un fonctionnement extrêmement silencieux.

**EN** — Thanks to the 5 preset programs\* of the Maestro app (Comfort, Overnight, Power, Dynamic and Manual), the stove is now much easier to control and fuel consumption is optimised, ensuring greater comfort of use and extremely quiet operation.



**COMFORT**

**FR** — Idéal pour toutes les situations nécessitant un confort maximal.  
**EN** — Ideal for all situations requiring maximum comfort.

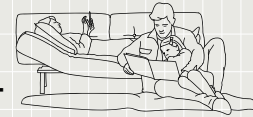

**OVERNIGHT**

**FR** — Garantit un silence maximale (avec bruit réduit jusqu'à 4 fois) et maintien de la température (même à convection naturelle).  
**EN** — It ensures extremely quiet operation (with reduced noise up to 4 times) and temperature maintenance (also with natural convection).



**TURBO**

**FR** — Lorsqu'une pièce doit être chauffée très rapidement (fonctionnement à 110 % de la puissance pendant 20 minutes, peut être réactivé toutes les heures).  
**EN** — When a room needs to be heated very quickly (110% power operation for 20 minutes, which can be reactivated every hour).

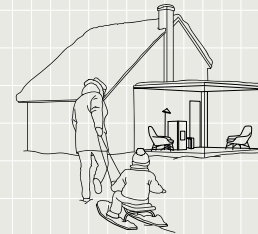

**AUTO**

**FR** — Si l'on préfère le fonctionnement automatique traditionnel avec la possibilité de définir la température et la ventilation.  
**EN** — If you prefer traditional automatic operation with the option of setting the temperature and ventilation.

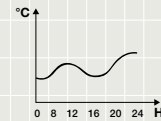

**MANUAL**

**FR** — Si l'on préfère le fonctionnement manuel traditionnel avec la possibilité de définir la puissance et la ventilation, sans contrôles sur la température.  
**EN** — If you prefer traditional automatic operation with the option of setting power and ventilation, without adjusting the temperature.

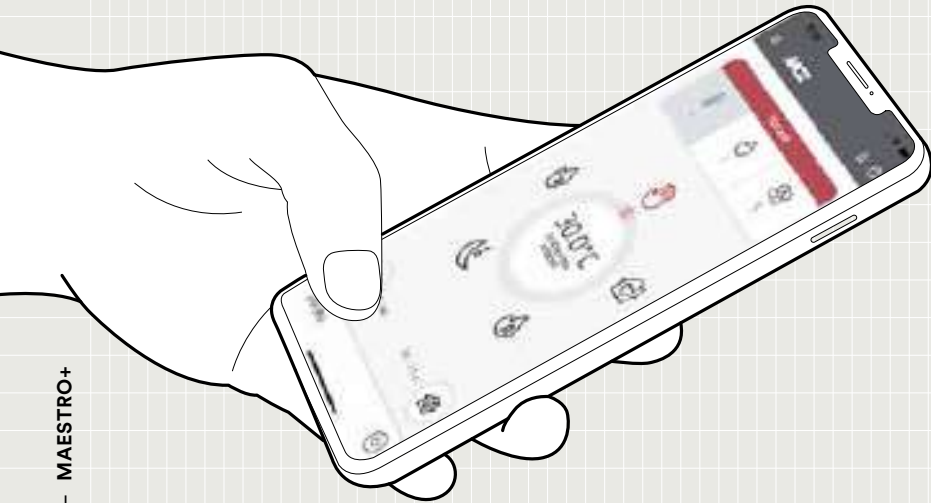

	Silence ** / Quiet operation	Confort *** / Comfort	Capacité de chauffage / Heating capacity	Baisse des consommations / Reduced consumption
COMFORT	●●●●○	●●●●●	●●●○○	●●●●○
OVERNIGHT	●●●●●	●●●●●	●○○○○	●●●●●
POWER	●○○○○	●●○○○	●●●●●	●○○○○
DYNAMIC	●●●○○	●●●○○	●●●●○	●●●○○
MANUAL	●○○○○	●○○○○	●●●●○	●●○○○

\*\* Lors du fonctionnement, lors de la phase d'allumage et d'arrêt. — During operation and when turning the appliance on/off.

\*\*\* Émission de chaleur progressive, nettoyage du verre et de la chambre de combustion). — Gradual heat emission, glass cleaning and combustion chamber cleaning.

\* Les modèles suivants seront dotés de la technologie Maestro+ courant 2022 / During 2022 the Maestro+ technology will be implemented on the following models: Jazz, Halo UPI, Mood, Flow, Curve, Berg.

# Mood

038

MCZ PELLETT — MOOD Comfort Air 8

039

MCZ PELLETT — MOOD Comfort Air 8



## Mood



**FR** — Poêle à pellets canalisable de forme ronde et au design minimaliste grâce à l'absence de grilles frontales. Adapté pour une installation d'angle, il présente un couvercle en aluminium peint noir et des cotés en acier couleur Bronze, Silver et Black. Possibilité de désactiver totalement la ventilation. Produit équipé d'une bougie d'allumage en céramique qui garantit des temps d'allumage réduits de 40 %. Ce produit offre plusieurs options d'utilisation. On peut choisir d'utiliser son smartphone, à la maison et à l'extérieur, ou de gérer le poêle à la maison via la télécommande « freestanding » avec thermostat d'ambiance (en option) ou via le panneau de contrôle (en option).

**EN** — Round ductable pellet stove with minimalist design, thanks to the absence of front vents. Suitable for corner installation, with top in black coated aluminium and steel sides in the colours Bronze, Silver and Black. Possibility to totally exclude the ventilation. Product equipped with ceramic spark plug ensuring ignition times reduced by 40%. This product offers several application options. You can choose to use your smartphone, both when at home and away, or to control the stove at home with the (optional) freestanding remote control with room thermostat or the (optional) control panel.

→ Technical data p.176

En savoir plus sur la technologie:  
Find out more about the technology:  
**COMFORT AIR** p.044



## Halo · Halo UP!



**FR** — Poêle à pellets sans bouches frontales, réalisé en acier noir et grilles frontal coloré (Aluminium, Silver, Dark, Bordeaux). Particulièrement indiqué pour une installation d'angle. Possibilité de désactiver totalement la ventilation. Produit équipé d'une bougie d'allumage en céramique qui garantit des temps d'allumage réduits de 40 %. Halo (Maestro+) : Il est possible de gérer ce poêle via un tableau de commande escamotable, une télécommande autonome avec un thermostat d'ambiance (en option) ou bien via un smartphone (WI-FI ; Bluetooth), en étant aussi bien chez soi qu'à l'extérieur. Halo UP! (Maestro) : on peut choisir d'utiliser son smartphone, à la maison et à l'extérieur, ou de gérer le poêle à la maison via la télécommande « freestanding » avec thermostat d'ambiance (en option) ou via le panneau de contrôle (en option).

**EN** — Pellet stove with no front vents, made in black steel with a coloured front panel (Aluminium, Silver, Dark, Bordeaux). Particularly suitable for corner installation. Possibility to totally exclude the ventilation. Product equipped with ceramic spark plug ensuring ignition times reduced by 40%. Halo (Maestro+): his stove can be managed via a retractable control panel, freestanding remote control with room thermostat (optional) or from a smartphone (WI-FI; Bluetooth), at home as well as away. Halo UP! (Maestro): You can choose to use your smartphone, both when at home and away, or to control the stove at home with the (optional) freestanding remote control with room thermostat or the (optional) control panel.

→ Technical data p.177

En savoir plus sur la technologie:  
Find out more about the technology:  
**MAESTRO+** (Halo) p.032



# COMFORT AIR, CONFORT TOTALE — COMFORT AIR, TOTAL COMFORT

044

MCZ PELLETT — COMFORT AIR

1

FR — LES PREMIÈRS DIFFUSEURS DESIGN disponibles avec plusieurs finitions (métal, verre ou céramique), avec une fonction d'illumination exclusive.  
EN — THE FIRST DESIGN DIFFUSERS, available in several finishes (metal, glass or ceramic), with the exclusive lighting function.



SOFT



FLOAT



MINIMAL



FLIP

2

FR — AIR CHAUD CANALISABLE jusqu'à 8 mètres.  
EN — HOT AIR CAN BE CHANNELLED by ducts up to 8 meters.

3

FR — DIFFUSEURS DÉPLAÇABLES LIBREMENT, même à proximité du sol.  
EN — DIFFUSERS FREELY POSITIONED even near the floor.

4

FR — INSTALLATION ET ENTRETIEN SIMPLES grâce à des diamètres réduits (60 mm et 100 mm).  
EN — EASY INSTALLATION AND MAINTENANCE thanks to the small diameters (60 mm e 100 mm).

5

FR — CONTRÔLE TOTAL DE LA DIFFUSION D'AIR grâce à deux ventilations indépendantes, et réglables électroniquement.  
EN — TOTAL CONTROL OF AIR DIFFUSION thanks to two independent fans that can be electrically adjusted.



045

MCZ PELLETT — COMFORT AIR



# Curve

046

MCZ PELLETT — CURVE Comfort Air 8



MCZ PELLETT — CURVE Comfort Air 8

## Curve



**FR** — Poêle à pellets canalisable sans grilles frontales, réalisé avec un habillage en céramique coloré (White, Warm Grey, Bordeaux, Black) et particulièrement adapté pour une installation d'angle. Possibilité de désactiver totalement la ventilation. Produit équipé d'une bougie d'allumage en céramique qui garantit des temps d'allumage réduits de 40 %. Ce produit offre plusieurs options d'utilisation. On peut choisir d'utiliser son smartphone, à la maison et à l'extérieur, ou de gérer le poêle à la maison via la télécommande « freestanding » avec thermostat d'ambiance (en option).

**EN** — Ductable pellet stove without front vents, with coloured ceramic cladding (White, Warm Grey, Bordeaux, Black) and particularly suitable for corner installation. Possibility to totally exclude the ventilation. Product equipped with ceramic spark plug ensuring ignition times reduced by 40%. This product offers several application options. You can choose to use your smartphone, both when at home and away, or to control the stove at home with the (optional) freestanding remote control with room thermostat.

→ Technical data p.177

En savoir plus sur la technologie:  
Find out more about the technology:  
**COMFORT AIR** p.044



Flow

050

MCZ PELLETT — FLOW Comfort Air 10



MCZ PELLETT — FLOW Comfort

## Flow

**FR** — Poêle à pellets au habillage en acier et céramique à finition lisse (Plain White, Plain Black) ou rayée (Line White, Line Bordeaux). Produit canalisable (2 moteurs, 1 canalisation + sortie sur le devant), équipé d'une bougie en céramique qui garantit une réduction des temps d'allumage de 40 %. Ce produit offre plusieurs options d'utilisation. On peut choisir d'utiliser son smartphone, à la maison et à l'extérieur, ou de gérer le poêle à la maison via la télécommande « freestanding » avec thermostat d'ambiance (en option) ou via le panneau de contrôle (en option). Grâce à la nouvelle application avec 5 réglages de fonctionnement préconfigurés, la consommation du combustible est optimisée et le confort d'utilisation s'améliore, pouvant atteindre un fonctionnement extrêmement silencieux.

**EN** — Pellet stove featuring a steel and ceramic cladding with a smooth (Plain White, Plain Black) or grooved finish (Line White, Line Bordeaux). Ductable product (2 motors, 1 ducting + front outlet), equipped with ceramic glow plug assuring 40% faster ignition times. This product offers several application options. You can choose to use your smartphone, both when at home and away, or to control the stove at home with the (optional) freestanding remote control with room thermostat or the (optional) control panel. Thanks to the new app with 5 preset operating settings, fuel consumption is optimised and improves the comfort of use, making it possible to achieve extremely noiseless operation.

→ Technical data p.178

En savoir plus sur la technologie:

Find out more about the technology:

COMFORT AIR p.044



Reflex

054

MCZ PELLETT — REFLEX Comfort Air 8



055

MCZ PELLETT — REFLEX Comfort Air 8

# Reflex

design Michael Geldmacher

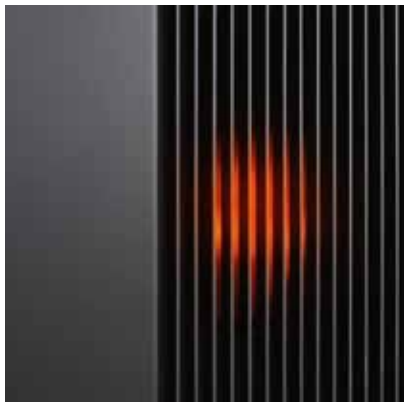

**FR** — Poêle à pellets canalisable à profondeur réduite (31,1 cm) avec revêtement en aluminium monocolore (Black) ou bicolore (Black/Gold, Black/Bronze). La perception de la flamme varie selon l'angle de vue, ce qui rend la présence du feu dans l'environnement domestique unique. Produit hermétique équipé d'une bougie en céramique garantissant des temps d'allumage réduits de 40 %. Il est possible de gérer ce poêle via un tableau de commande escamotable, une télécommande autonome avec un thermostat d'ambiance (en option) ou bien via un smartphone (WI-FI ; Bluetooth), en étant aussi bien chez soi qu'à l'extérieur.

**EN** — Ductable pellet stove with reduced depth (31,1 cm) and monochrome (Black) or two-tone (Black/Gold, Black/Bronze) aluminium cladding. The flame is perceived differently according to the viewing angle, which makes having a fire at home truly special. Airtight product equipped with ceramic glow plug for 40% faster ignition times. This stove can be managed via a retractable control panel, freestanding remote control with room thermostat (optional) or from a smartphone (WI-FI; Bluetooth), at home as well as away.

→ Technical data p.178

En savoir plus sur la technologie:

Find out more about the technology:

**MAESTRO+** p.032

**COMFORT AIR** p.044



Ray · Ray UP! · Ray XUP!

058

MCZ PELLET — RAY / RAY UP! / RAY XUP! Comfort Air 8



059

MCZ PELLET — RAY / RAY UP! / RAY XUP! Comfort Air 8

## Ray · Ray UP! · Ray XUP!



**FR** — Poêle à pellets canalisable particulièrement adapté aux espaces étroits, grâce à sa profondeur réduite (29 cm). Habillage en pierre, en céramique (White, Bordeaux, Black) ou en métal (White, Bordeaux, Black, Silver). Produit hermétique, équipé d'une bougie en céramique qui garantit une réduction des temps d'allumage de 40 %. Il est possible de gérer ce poêle via un tableau de commande escamotable, une télécommande autonome avec un thermostat d'ambiance (en option) ou bien via un smartphone (WI-FI ; Bluetooth), en étant aussi bien chez soi qu'à l'extérieur.

**EN** — Compact ductable pellet stove (29cm deep) ideal for confined spaces. Cladding made of stone, ceramic (White, Bordeaux, Black) or metal (White, Bordeaux, Black, Silver). Airtight product equipped with ceramic spark plug for 40% faster ignition times. This stove can be managed via a retractable control panel, freestanding remote control with room thermostat (optional) or from a smartphone (WI-FI; Bluetooth), at home as well as away.

→ Technical data p.179

En savoir plus sur la technologie:

Find out more about the technology:

**MAESTRO+** p.032

**COMFORT AIR** p.044





Doc · Doc UP!

062

MCZ PELLETT — DOC / DOC UP! Comfort Air 9



063

MCZ PELLETT — DOC / DOC UP! Comfort Air 9

## Doc · Doc UP!



**FR** — Poêle à pellets particulièrement adapté pour des espaces étroits, grâce à sa profondeur très réduite (29cm). Couvercle en fonte peinte Black ou Aluminium, et habillage en acier peint Black. Chargement frontal du pellet. Deux portes dont une esthétique. Produit hermétique, équipé d'une bougie d'allumage en céramique qui garantit des temps d'allumage réduits de 40 %. Polyvalence maximale dans la distribution de l'air en phase d'installation grâce à la possibilité de canaliser les deux sorties d'air. Il est possible de gérer ce poêle via un tableau de commande escamotable, une télécommande autonome avec un thermostat d'ambiance (en option) ou bien via un smartphone (WI-FI ; Bluetooth), en étant aussi bien chez soi qu'à l'extérieur.

→ Technical data p.179  
En savoir plus sur la technologie:  
Find out more about the technology:  
**MAESTRO+** p.032  
**COMFORT AIR** p.044



**EN** — Highly compact pellet stove (29cm deep) ideal for confined spaces. Cast iron top painted Black or Aluminium and steel cladding painted Black. Pellet loading at front. Double door. Airtight product equipped with ceramic spark plug for 40% faster ignition times. Both air outlets can be ducted to ensure absolute versatility of air distribution during installation. This stove can be managed via a retractable control panel, freestanding remote control with room thermostat (optional) or from a smartphone (WI-FI; Bluetooth), at home as well as away.



Stream · Stream UP!



## Stream · Stream UP!



**FR** — Poêle à pellet réalisé avec une structure en acier peint, porte en verre et habillage frontal en pierre serpentine ou en acier peint de couleur blanche, bordeaux, sombre. Brasero en fonte. Nouveau foyer aux lignes adoucies. Produit équipé d'une bougie en céramique qui garantit des temps d'allumage réduits de 40 %. Il est possible de gérer ce poêle via un tableau de commande escamotable, une télécommande autonome avec un thermostat d'ambiance (en option) ou bien via un smartphone (WI-FI ; Bluetooth), en étant aussi bien chez soi qu'à l'extérieur. La version Comfort Air est dotée de 3 ventilateurs réglables de manière indépendante.

→ Technical data p.180  
 En savoir plus sur la technologie:  
 Find out more about the technology:  
**MAESTRO+** p.032  
**COMFORT AIR** p.044



**EN** — Pellet stove with a painted steel structure, glass door and serpentine stone or painted steel cladding, either White, Bordeaux, Dark. Cast iron brazier. The new firebox featuring curved lines. Product equipped with ceramic spark plug ensuring ignition times reduced by 40%. This stove can be managed via a retractable control panel, freestanding remote control with room thermostat (optional) or from a smartphone (WI-FI; Bluetooth), at home as well as away. The Comfort Air version has 3 fans that can be set separately.



## Philo · Philo UP!



**FR** — Poêle à pellets particulièrement adapté aux espaces étroits, grâce à sa profondeur réduite (39 cm) ; caractérisé par 3 ventilateurs et deux flux d'air orientables à souhait en fonction des besoins de chauffage de la pièce. Couvercle en acier noir, grille en aluminium, habillage en métal de couleur White, Bordeaux, Black, Bronze, Aluminium. Produit hermétique, équipé d'une bougie en céramique qui garantit une réduction des temps d'allumage de 40 %. Il est possible de gérer ce poêle via un tableau de commande escamotable, une télécommande autonome avec un thermostat d'ambiance (en option) ou bien via un smartphone (WI-FI ; Bluetooth), en étant aussi bien chez soi qu'à l'extérieur.

→ Technical data p.180  
En savoir plus sur la technologie:  
Find out more about the technology:  
**MAESTRO+** p.032  
**COMFORT AIR** p.044



**EN** — Pellet stove particularly suitable for confined spaces, thanks to the reduced depth (39 cm); featuring 3 fans and two air flows that you can adjust to fit your needs, based on the heating requirements of the room. Black steel top, aluminium grid and White, Bordeaux, Black, Bronze, Aluminium metal cladding. Airtight product equipped with ceramic spark plug for 40% faster ignition times. This stove can be managed via a retractable control panel, freestanding remote control with room thermostat (optional) or from a smartphone (WI-FI; Bluetooth), at home as well as away.



## Philo · Philo UP!

Flux d'air orientables librement.  
— Air flows adjustable as needed.



072

MCZ PELLET — PHILO / PHILO UP! Comfort Air 14



073

MCZ PELLET — PHILO / PHILO UP! Comfort Air 14



# Aki



## Aki

**FR** — Poêle à pellets hydro avec côtés en céramique Sand, Bordeaux, White ou en métal Black, White, Silver. Produit équipé d'un brasier autonettoyant en fonte avec vidage des cendres hebdomadaire et système de récupération automatique des cendres (depuis le compartiment principal et depuis le compartiment de circulation de fumée), équipé d'une bougie en céramique qui garantit une réduction des temps d'allumage de 40 %. Évacuation arrière ou supérieure. Il est possible de gérer ce poêle via un tableau de commande escamotable, une télécommande autonome avec un thermostat d'ambiance (en option) ou bien via un smartphone (WI-FI ; Bluetooth), en étant aussi bien chez soi qu'à l'extérieur.

→ Technical data p.181  
En savoir plus sur la technologie:  
Find out more about the technology:  
**MAESTRO+** p.032  
**MATIC** p.116



**EN** — Hydro pellet stove with sides in Sand, Bordeaux, White ceramic or Black, White, Silver metal. The product is equipped with a self-cleaning brazier with weekly emptying of the ash and an automatic ash collection system (from the main compartment and the smoke circulation system), fitted with a ceramic glow plug that guarantees a 40% faster ignition time. Rear or top outlet. This stove can be managed via a retractable control panel, freestanding remote control with room thermostat (optional) or from a smartphone (WI-FI; Bluetooth), at home as well as away.





# Alyssa



**FR** — Poêle à pellets au look moderne avec couvercle en fonte et côtés en céramique (White, Warm Grey, Bordeaux). Possibilité de désactiver totalement la ventilation. Produit équipé d'une bougie en céramique qui garantit une réduction des temps d'allumage de 40 %. Il est possible de gérer ce poêle via un tableau de commande escamotable, une télécommande autonome avec un thermostat d'ambiance (en option) ou bien via un smartphone (WI-FI ; Bluetooth), en étant aussi bien chez soi qu'à l'extérieur.

**EN** — Pellet stove with a modern look with cast iron top and ceramic sides (White, Warm Grey, Bordeaux). Possibility to totally exclude the ventilation. Product equipped with ceramic glow plug ensuring ignition times reduced by 40%. This stove can be managed via a retractable control panel, freestanding remote control with room thermostat (optional) or from a smartphone (WI-FI; Bluetooth), at home as well as away.

→ Technical data p.181  
 En savoir plus sur la technologie:  
 Find out more about the technology:  
**MAESTRO+** p.032



## Tecla



**FR** — Poêle à pellets au look moderne avec couvercle en fonte et côtés en acier peint (Bordeaux, White, Dark, Silver). Possibilité de désactiver totalement la ventilation. Produit équipé d'une bougie en céramique qui garantit une réduction des temps d'allumage de 40 %. Il est possible de gérer ce poêle via un tableau de commande escamotable, une télécommande autonome avec un thermostat d'ambiance (en option) ou bien via un smartphone (WI-FI ; Bluetooth), en étant aussi bien chez soi qu'à l'extérieur.

→ Technical data p.182

En savoir plus sur la technologie:  
Find out more about the technology:  
**MAESTRO+** p.032



**EN** — Pellet stove with a modern look with cast iron top and painted steel sides (Bordeaux, White, Dark, Silver). Possibility to totally exclude the ventilation. Product equipped with ceramic glow plug ensuring ignition times reduced by 40%. This stove can be managed via a retractable control panel, freestanding remote control with room thermostat (optional) or from a smartphone (WI-FI; Bluetooth), at home as well as away.



Ego · Ego UP! · Ego XUP!

MCZ PELLETT — EGO / EGO UP! Air 8, Comfort Air 10, Hydro Matic 12 / EGO XUP! Air 8 082

MCZ PELLETT — EGO / EGO UP! Air 8, Comfort Air 10, Hydro Matic 12 / EGO XUP! Air 8 083



## Ego · Ego UP! · Ego XUP!



**FR** — Poêle à pellets avec structure en acier, couvercle en fonte, revêtement en acier de couleur White, Dark, Silver, Bordeaux. Trappe d'ouverture du réservoir plus grande afin de faciliter le chargement des pellets. Brasier en fonte et nouvelle conception du foyer offrant une vue agréable même quand le poêle est éteint. Possibilité de désactiver totalement la ventilation (pour les modèles Air et Comfort air). Produit équipé d'une bougie en céramique qui garantit des délais d'allumage réduits de 40 %. La version Comfort Air est équipée de deux ventilateurs réglables de manière indépendante. La version Matic est équipée d'un brasier autonettoyant avec vidage des cendres hebdomadaire. Disponible en version à évacuation supérieure et coaxiale intégrée à l'intérieur du poêle (uniquement pour la version Air 8). Ce produit peut être géré via un tableau de commande escamotable ou bien via un smartphone (Wi-Fi; Bluetooth).

→ Technical data p.190

En savoir plus sur la technologie:  
Find out more about the technology:  
**CORE** p.014 / **MAESTRO+** p.032  
**COMFORT AIR** p.044 / **MATIC** p.116

### AIR / COMFORT AIR



**EN** — Pellet stove with steel structure, cast iron top, White, Dark, Silver, Bordeaux steel cladding. More generously-sized hopper inlet for loading pellet more easily. Cast iron brazier and redesigned firebox for a pleasant appearance even when the stove is off. Option to wholly exclude ventilation (models Air and Comfort air). Product fitted with ceramic glow plug which ensures switch-on is 40% faster. The Comfort Air version is fitted with two fans that can be set up separately. The Matic version is fitted with a self-cleaning brazier with weekly ash emptying. Available in the version with built-in top and coaxial outlet inside the stove (only Air 8 version). This stove can be managed via a retractable control panel or from a smartphone (Wi-Fi; Bluetooth).

### HYDRO MATIC

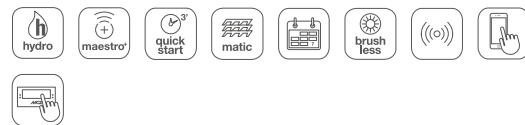

## Ego · Ego UP! · Ego XUP!

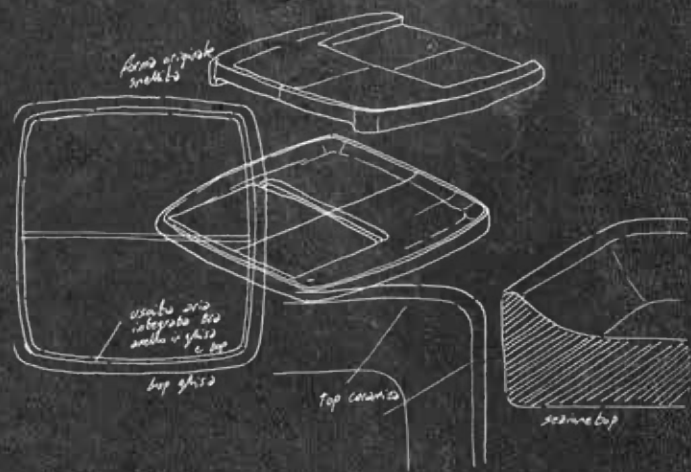

**FR** — Le couvercle est conçu de manière à cacher les parties techniques situées dessous tout en garantissant une vaste surface d'évacuation de la chaleur tout le long du périmètre du poêle. Grâce à sa forme particulière, la bague en fonte facilite le mouvement naturel de l'air vers le haut.

**EN** — The top has been designed to conceal the underlying technical parts and ensure a wide heat irradiation surface around the entire perimeter of the stove. With its special shape, the cast iron ring promotes the air's natural movement upwards.



Star · Star UP!

088

MCZ PELLET — STAR / STAR UPI Air 8, Comfort Air 10, Hydro Matic 12



089

MCZ PELLET — STAR / STAR UPI Air 8, Comfort Air 10, Hydro Matic 12



## Star · Star UP!



**FR** — Poêle à pellet réalisé avec une structure en acier, un couvercle et des flancs en céramique. Brasero en fonte. Possibilité de désactiver totalement la ventilation (Air, Comfort Air). Produit équipé d'une bougie en céramique qui garantit des temps d'allumage réduits de 40 %. La version Comfort Air est équipée de deux ventilateurs réglables de manière indépendante. Nouvelle version Hydro Matic équipée d'un brasier autonettoyant avec vidage des cendres hebdomadaire. Ce produit offre plusieurs options d'utilisation. On peut choisir d'utiliser son smartphone, à la maison et à l'extérieur, ou de gérer le poêle à la maison via la télécommande « freestanding » avec thermostat d'ambiance (en option) ou via le panneau de contrôle (en option).

→ Technical data p.192

En savoir plus sur la technologie:

Find out more about the technology:

**MAESTRO+** p.032

**COMFORT AIR** p.044

**MATIC** p.116

### AIR / COMFORT AIR

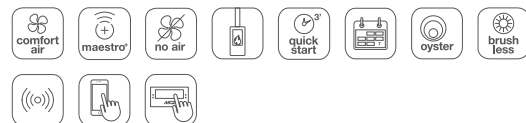

**EN** — Pellet stove with steel structure, ceramic top and sides. Cast iron brazier. Possibility to totally exclude the ventilation (Air, Comfort Air). The new firebox featuring curved lines. Product equipped with ceramic spark plug ensuring ignition times reduced by 40%. The Comfort Air version has two fans that can be set separately. New Hydro Matic version, equipped with self-cleaning brazier, with weekly ash emptying. This product offers several application options. You can choose to use your smartphone, both when at home and away, or to control the stove at home with the (optional) freestanding remote control with room thermostat or the (optional) control panel.

### HYDRO MATIC

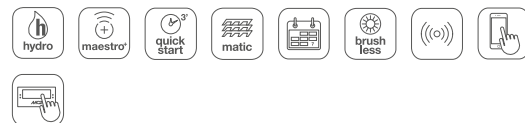

Suite · Suite UP!





## Suite · Suite UP!

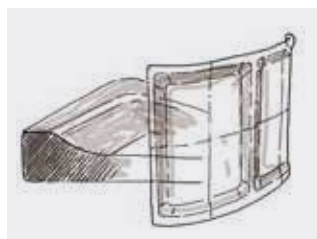

**FR** — Poêle à pellets avec structure en acier et habillage entièrement en céramique de couleur Salt&Pepper, Bordeaux, Warm Grey, Matt Black. Trappe d'ouverture du réservoir plus grande afin de faciliter le chargement des pellets. Brasier en fonte et nouvelle conception du foyer offrant une vue agréable même quand le poêle est éteint. Possibilité de désactiver totalement la ventilation (pour les modèles Air). Produit équipé d'une bougie en céramique qui garantit une réduction des temps d'allumage de 40 %. La version Comfort Air est équipée de deux sorties postérieures et de trois ventilateurs réglables de manière indépendante. La version Matic est dotée d'un brasier autonettoyant avec vidage des cendres hebdomadaire. Disponible dans la version avec évacuation supérieure. Il est possible de gérer ce poêle via un tableau de commande escamotable ou bien via un smartphone (Wi-Fi; Bluetooth).

→ Technical data p.194  
 En savoir plus sur la technologie:  
 Find out more about the technology:  
**CORE** p.014 / **MAESTRO+** p.032  
**COMFORT AIR** p.044 / **MATIC** p.116

### AIR / COMFORT AIR



**EN** — Pellet stove made with steel structure and Salt&Pepper, Bordeaux, Warm Grey, Matt Black cladding entirely in ceramic. More generously-sized hopper inlet for loading pellet more easily. Cast iron brazier and redesigned firebox for a pleasant appearance even when the stove is off. Option to wholly exclude ventilation (Air models). Product equipped with ceramic glow plug for 40% faster ignition times. The Comfort Air version has two outlets at the back and three fans that can be set separately. The Matic version is fitted with a self-cleaning brazier with weekly ash emptying. Available in the version with top outlet. This stove can be managed via a retractable control panel from a smartphone (Wi-Fi; Bluetooth).

### HYDRO MATIC

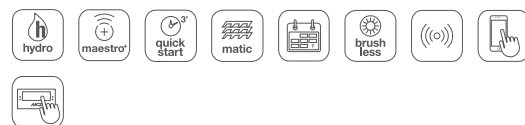

Club · Club UP!

096

MCZ PELLETT — CLUB / CLUB UP! Air 10, Comfort Air 12-14, Hydro Matic 18-24



097

MCZ PELLETT — CLUB / CLUB UP! Air 10, Comfort Air 12-14, Hydro Matic 18-24

**Club · Club UP!**



## Club · Club UP!



**FR** — Poêle à pellets avec structure en acier et habillage entièrement en céramique de couleur White, Bordeaux, Matt Black, Sand. Trappe d'ouverture du réservoir plus grande afin de faciliter le chargement des pellets. Brasier en fonte et nouvelle conception de foyer offrant une vue agréable même quand le poêle est éteint. Possibilité de désactiver totalement la ventilation (pour les modèles Air). Produit équipé d'une bougie en céramique qui garantit une réduction des temps d'allumage de 40 %. La version Comfort Air est équipée de deux sorties postérieures et de trois ventilateurs réglables de manière indépendante. La version Matic est dotée d'un brasier autonettoyant avec vidage des cendres hebdomadaire. Disponible dans la version avec évacuation supérieure. Il est possible de gérer ce poêle via un tableau de commande escamotable ou bien via un smartphone (Wi-Fi; Bluetooth).

**EN** — Pellet stove made with steel structure and White, Bordeaux, Matt Black, Sand cladding entirely in ceramic. More generously-sized hopper inlet for loading pellet more easily. Cast iron brazier and redesigned firebox for an appealing look even with stove switched off. Option to completely exclude ventilation (Air models). Product equipped with ceramic glow plug for 40% faster ignition times. The Comfort Air version has two outlets at the back and three fans that can be set separately. The Matic version is fitted with a self-cleaning brazier with weekly ash emptying. Available in the version with top outlet. This stove can be managed via a retractable control panel or from a smartphone (Wi-Fi; Bluetooth).

→ Technical data p.196

En savoir plus sur la technologie:  
Find out more about the technology:  
**CORE** p.014 / **MAESTRO+** p.032  
**COMFORT AIR** p.044 / **MATIC** p.116

### AIR / COMFORT AIR



### HYDRO MATIC

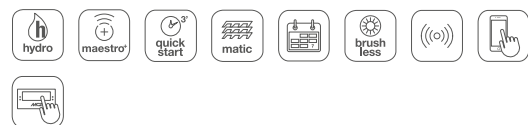

Musa · Musa UP!

MCZ PELLET — MUSA / MUSA UPI Air 10, C-Air 12 - 14, C-Air Matic 14, Hydro Matic 18 - 24 102



MCZ PELLET — MUSA / MUSA UPI Air 10, C-Air 12 - 14, C-Air Matic 14, Hydro Matic 18 - 24 103



## Musa · Musa UP!

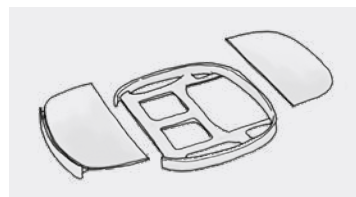
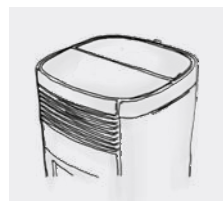

**FR** — Poêle à pellet réalisé avec une structure en acier, un couvercle en fonte et des flancs en acier. Brasero en fonte. Possibilité de désactiver totalement la ventilation (Air, Comfort Air). Produit équipé d'une bougie en céramique qui garantit des temps d'allumage réduits de 40 %. Ce produit offre plusieurs options d'utilisation. On peut choisir d'utiliser son smartphone, à la maison et à l'extérieur, ou de gérer le poêle à la maison via la télécommande « freestanding » avec thermostat d'ambiance (en option) ou via le panneau de contrôle (en option). La version Comfort Air est équipée de deux sorties postérieures et de trois ventilateurs réglables de manière indépendante. Nouvelle version Matic équipée d'un brasier autonettoyant avec vidage des cendres hebdomadaire. Disponible avec sortie des fumées supérieure.

**EN** — Pellet stove made with a steel structure, cast iron top and steel sides. Cast iron brazier. Possibility to totally exclude the ventilation (Air, Comfort Air). Product equipped with ceramic spark plug ensuring ignition times reduced by 40%. This product offers several application options. You can choose to use your smartphone, both when at home and away, or to control the stove at home with the (optional) freestanding remote control with room thermostat or the (optional) control panel. The Comfort Air version has two outlets at the back and three fans that can be set separately. New Matic version, equipped with self-cleaning brazier. Available in the version with top exhaust.

→ Technical data p.198  
 En savoir plus sur la technologie:  
 Find out more about the technology:  
**CORE** p.014 / **MAESTRO+** p.032  
**COMFORT AIR** p.044 / **MATIC** p.116

### AIR / COMFORT AIR



### HYDRO MATIC

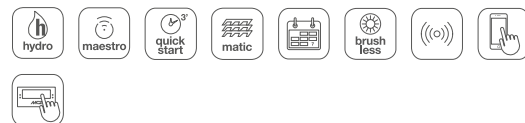

# Pad





Pad



## Pad



01

- 01 — Line White
- 02 — Line Bordeaux
- 03 — Plain Black
- 04 — Plain White



03



02



04

**FR** — Poêle à pellets hydro avec habillages en céramique en finition lisse (White, Black) ou rayée (White, Bordeaux), couvercle en fonte au design épuré et grille frontale qui devient un prolongement naturel de la grande vitre. Brasier en fonte. Produit équipé d'une bougie en céramique qui garantit des délais d'allumage réduits de 40 % et équipée d'un brasier autonettoyant avec vidage des cendres hebdomadaire. Évacuation arrière. Il est possible de gérer ce poêle via un tableau de commande escamotable, une télécommande autonome avec un thermostat d'ambiance (en option) ou bien via un smartphone (WI-FI ; Bluetooth), en étant aussi bien chez soi qu'à l'extérieur.

**EN** — Hydro pellet stove with ceramic cladding in smooth finish (White, Black) or grooved finish (White, Bordeaux), top in cast iron with an essential design and front grille that becomes a natural extension of the wide glass. Cast iron brazier. Product fitted with ceramic glow plug that ensures 40% faster switch-on times and fitted with self-cleaning brazier with weekly ash emptying. Rear outlet. This stove can be managed via a retractable control panel, freestanding remote control with room thermostat (optional) or from a smartphone (WI-FI; Bluetooth), at home as well as away.

→ Technical data p.182

En savoir plus sur la technologie:

Find out more about the technology:

**maestro+ p.32**

**MATIC p.116**



# Jazz

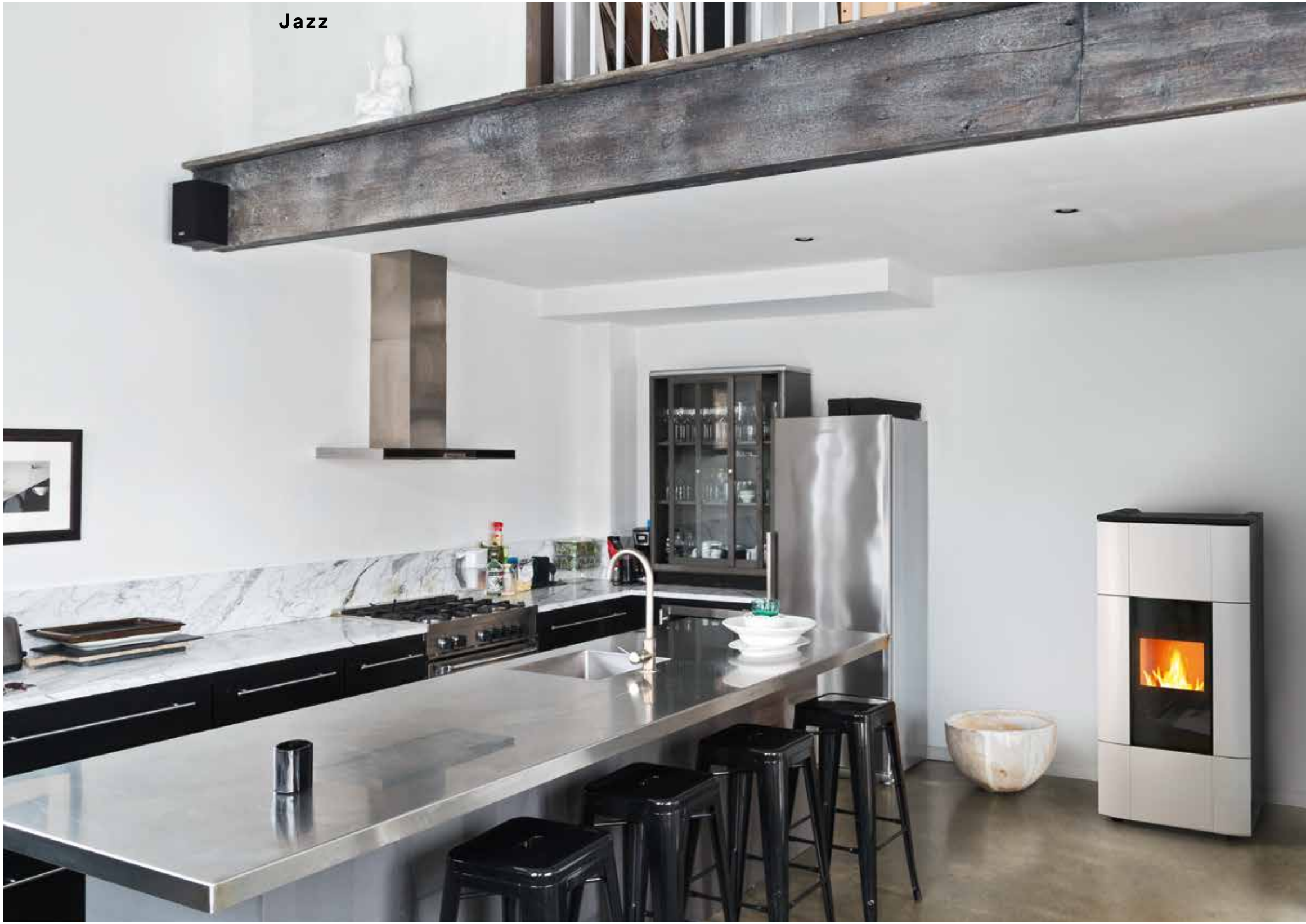

## Jazz



**FR** — Poêle à pellets réalisé avec panneau frontal en céramique de couleur White, Bordeaux ou Black, couvercle en fonte et côtés en métal noir. Produit équipée d'un brasier autonettoyant en fonte avec vidage des cendres hebdomadaire et système de récupération automatique des cendres (depuis le compartiment principal et depuis le compartiment de circulation de fumée), équipé d'une bougie en céramique qui garantit une réduction des temps d'allumage de 40 %. Ce produit offre plusieurs options d'utilisation. On peut choisir d'utiliser son smartphone, à la maison et à l'extérieur, ou de gérer le poêle à la maison via la télécommande « freestanding » avec thermostat d'ambiance (en option) ou via le panneau de contrôle (en option).

→ Technical data p.183

En savoir plus sur la technologie:

Find out more about the technology:

**MATIC** p.122



**EN** — Pellet stove made with ceramic front in White, Bordeaux or Black, cast iron top and black metal sides. Fitted with a self-cleaning brazier with weekly emptying of the ash and an automatic ash collection system (from the main compartment and the smoke circulation system), fitted with a ceramic spark plug that guarantees a 40% faster ignition time. This product offers several application options. You can choose to use your smartphone, both when at home and away, or to control the stove at home with the (optional) freestanding remote control with room thermostat or the (optional) control panel.

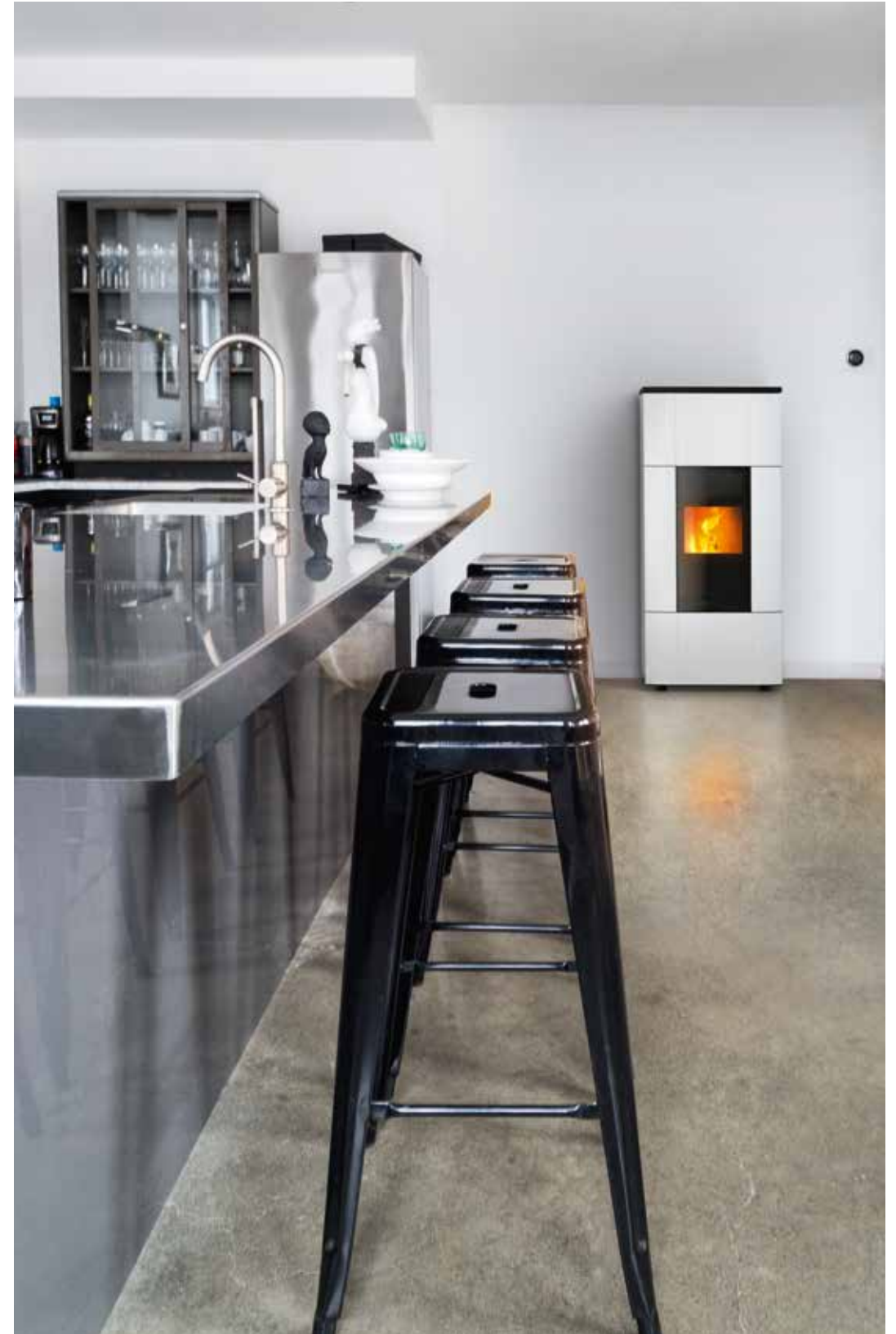

# MATIC

## IL S'OCCUPE DE TOUT

### — MATIC IT TAKES CARE OF EVERYTHING

1

FR — Brasier autonettoyant automatique avec mécanisme à brosse pour un nettoyage plus efficace.

EN — Automatic self-cleaning brazier with comb mechanism for a more effective cleaning.

2

FR — Moteur sans balais à haut rendement spécifique au système autonettoyant

EN — High-efficiency Brushless motor dedicated to the self-cleaning system.

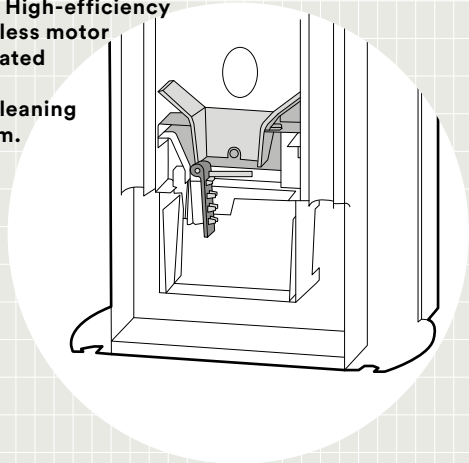

3

FR — Rendement maximal de la combustion grâce aux composants électroniques : ceux-ci définissent le nettoyage mécanique avec des cycles réguliers, ou dans le cas d'obstructions.

EN — Utmost combustion efficiency thanks to the electronics that defines the mechanical cleaning in regular cycles or in case of blockages.

4

FR — Disponibilité aussi bien sur des versions à eau, qu'à air à haute puissance (14 kW).

EN — Availability both on water and high power air versions (14kW).

5

FR — Tiroir à cendres permettant un vidage hebdomadaire ou plus fréquent.

EN — Ash pan allowing the emptying on a weekly basis or beyond.



Decò



## Decò



**FR** — Poêle à pellets au design classique avec habillage et foyer entièrement réalisés en fonte. L'ouverture du réservoir à pellets à glissière facilite considérablement les opérations de chargement. Possibilité de désactiver totalement la ventilation. Il est possible de gérer ce poêle via un tableau de commande escamotable, une télécommande autonome avec un thermostat d'ambiance (en option) ou bien via un smartphone (WI-FI ; Bluetooth), en étant aussi bien chez soi qu'à l'extérieur.

→ Technical data p.183

En savoir plus sur la technologie:  
Find out more about the technology:  
**MAESTRO+** p.032



**EN** — Classic-style pellet stove, with cladding and firebox entirely made of cast iron. The sliding opening of the pellet tank makes loading operations extremely easy. Possibility to totally exclude the ventilation. This stove can be managed via a retractable control panel, freestanding remote control with room thermostat (optional) or from a smartphone (WI-FI; Bluetooth), at home as well as away.



## Cute

**FR** — Poêle à pellets au design classique et contemporain à la fois ; il possède un habillage en acier laqué noir et une porte en fonte. Possibilité de désactiver totalement la ventilation. Il est possible de gérer ce poêle via un tableau de commande escamotable, une télécommande autonome avec un thermostat d'ambiance (en option) ou bien via un smartphone (WI-FI ; Bluetooth), en étant aussi bien chez soi qu'à l'extérieur.

**EN** — Pellet-fuelled stove with a classic-contemporary design. It has a Black painted steel casing and a cast iron door. Possibility to totally exclude the ventilation. This stove can be managed via a retractable control panel, freestanding remote control with room thermostat (optional) or from a smartphone (WI-FI; Bluetooth), at home as well as away.



→ Technical data p.184

En savoir plus sur la technologie:

Find out more about the technology:

**MAESTRO+** p.032



## Vivo Maestro 90

**FR** — Cheminée à pellets au format panoramique pouvant être combinée aux systèmes de canalisation de l'air pour chauffer plusieurs espaces même s'ils ne communiquent pas entre eux. Le brasier et le foyer sont en fonte noire. Produit équipé d'une bougie en céramique qui garantit une réduction des temps d'allumage de 40 %. Cette cheminée peut être installée à proximité du sol. Ce produit offre plusieurs options d'utilisation. On peut choisir d'utiliser son smartphone, à la maison et à l'extérieur, ou de gérer le poêle à la maison via la télécommande « freestanding » avec thermostat d'ambiance (en option).

**EN** — Pellet fireplace with a large view, which can be combined with air ducting systems to heat several rooms, even non-communicating ones. Black cast iron brazier and firebox. Product equipped with ceramic glow plug ensuring ignition times reduced by 40%. This fireplace can be installed close to the floor. This product offers several application options. You can choose to use your smartphone, both when at home and away, or to control the stove at home with the (optional) freestanding remote control with room thermostat.



→ Technical data p.169

En savoir plus sur la technologie:  
Find out more about the technology:  
**COMFORT AIR** p.044

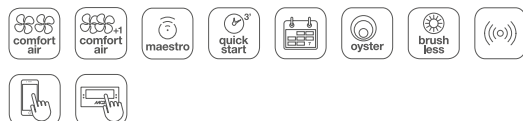



## Vivo Maestro 90 Hydro

126

MCZ PELLETT — VIVO MAESTRO 90 HYDRO Hydro 16 / 24

**FR** — Cheminée à pellets hydro pour chauffer plusieurs pièces grâce à un système centralisé. Équipé d'une ventilation frontale. Le brasier et le foyer sont en fonte noire. Produit équipé d'une bougie en céramique qui garantit une réduction des temps d'allumage de 40 %. Ce produit offre plusieurs options d'utilisation. On peut choisir d'utiliser son smartphone, à la maison et à l'extérieur, ou de gérer le poêle à la maison via la télécommande « freestanding » avec thermostat d'ambiance (en option).

→ Technical data p.171



**EN** — Hydro pellet fireplace to heat several rooms through a centralised system. Fitted with front ventilation. Black cast iron brazier and firebox. Product equipped with ceramic glow plug for 40% faster ignition times. This product offers several application options. You can choose to use your smartphone, both when at home and away, or to control the stove at home with the (optional) freestanding remote control with room thermostat.



127

MCZ PELLETT — VIVO MAESTRO 90 HYDRO Hydro 16 / 24

## Boxtherm Maestro



**FR** — Insert à pellets disponible en version Basic, à chargement frontal par tiroir intégré ou en version Slide, à chargement par extraction totale. Adapté pour l'insertion dans des foyers ouverts existants ou pour de nouvelles installations. Disponible en deux tailles (70 et 60). Ce produit offre plusieurs options d'utilisation. On peut choisir d'utiliser son smartphone, à la maison et à l'extérieur, ou de gérer le poêle à la maison via la télécommande « freestanding » avec thermostat d'ambiance (en option). Disponibilité d'un kit optionnel pour effectuer le chargement par une trappe dans la hotte.

**EN** — Pellet insert available in the Basic version, with front loading via a built-in drawer or in the Slide version, loaded via a full extraction system. Suitable for insertion in existing fireboxes or for new installations. Available in two sizes (70 and 60). This product offers several application options. You can choose to use your smartphone, both when at home and away, or to control the stove at home with the (optional) freestanding remote control with room thermostat. Optional kit for loading via the door in the hood.

→ Technical data p.173



# Sahara

design Paola Navone

130

MCZ PELLET — SAHARA Vivo 90 Comfort Air 9/11



**FR** — Habillage en carreaux réalisés à la main selon une composition particulière disponible en White ou en Grey. La fabrication artisanale et l'irrégularité des carreaux individuels contribuent à rendre l'environnement domestique toujours unique.

→ Technical data p.189

**EN** — Handmade tile covering made according to a special composition, available in White or Grey. The craftsmanship and unevenness of each tile gives home environments a unique feel.



131

MCZ PELLET — SAHARA Vivo 90 Comfort Air 9/11

LIGNE EASY,  
TOUT CE DONT  
VOUS AVEZ BESOIN  
AU JUSTE PRIX  
— EASY LINE,  
EVERYTHING YOU  
NEED AT THE  
RIGHT PRICE



May

Ghea

Mida

Teia

Hera

AIR



Alea

Raam

Teia

Clio

COMFORT AIR

HYDRO

# Ghea · Ghea XUP!



## Ghea · Ghea XUP!



**FR** — Poêle à pellets avec couvercle et porte en fonte, revêtement en acier bordeaux, blanc, silver, dark. Brasier en fonte. Évacuation supérieure (standard ou coaxiale) ou bien arrière (en option). Possibilité de désactiver totalement la ventilation. Il est possible de gérer le poêle via le tableau de commande intégré, la télécommande (en option) ou un smartphone (avec un kit en option - Easy Connect).

**EN** — Pellet stove with cast iron top and door, bordeaux, white, silver and dark steel cladding. Cast iron brazier. Top outlet (standard or coaxial) or rear outlet. Option of turning ventilation off completely. You can choose to manage the stove via the built-in control panel, remote control (optional) or smartphone (optional kit - Easy Connect).

→ Technical data p.185



## May

**FR** — Poêle à pellets avec couvercle et porte en fonte, habillage en acier bordeaux, blanc, argent, noir. Brasier et panneau arrière du foyer en fonte. Sortie des fumées postérieure ou supérieure (avec kit en option). Possibilité de désactiver totalement la ventilation. Il est possible de gérer le poêle via le tableau de commande intégré, la télécommande (en option) ou via un smartphone (avec un kit en option - Easy Connect).

**EN** — Pellet stove with cast iron top and door, burgundy, white, silver and black steel cladding. Cast iron brazier and firebox back panel. Rear or top outlet (with optional kit). Option of turning ventilation off completely. You can choose to manage the stove via the built-in control panel, remote control (optional) or smartphone (optional kit - Easy Connect).



→ Technical data p.184



Mida · Mida XUP!

140

MCZ PELLET — MIIDA / MIDA XUP! Air 8



141

MCZ PELLET — MIIDA / MIDA XUP! Air 8



## Mida · Mida XUP!



**FR** — Poêle à pellets avec couvercle et porte en fonte, revêtement en acier bordeaux, blanc, silver, dark. Brasier en fonte. Évacuation supérieure (standard ou coaxiale) ou bien arrière (en option). Possibilité de désactiver totalement la ventilation. Il est possible de gérer le poêle via le tableau de commande intégré, la télécommande (en option) ou un smartphone (avec un kit en option - Easy Connect).

**EN** — Pellet stove with cast iron top and door, bordeaux, white, silver and dark steel cladding. Cast iron brazier. Top outlet (standard or coaxial) or rear outlet. Option of turning ventilation off completely. You can choose to manage the stove via the built-in control panel, remote control (optional) or smartphone (optional kit - Easy Connect).

→ Technical data p.185





Teia • Teia UP!

## Teia · Teia UP!



**FR** — Poêle à pellets canalisable avec couvercle en fonte et côtés en acier peint bordeaux, blanc, dark. Brasier en fonte. Évacuation supérieure coaxiale ou arrière. Possibilité de désactiver totalement la ventilation. Produit équipé d'une bougie de préchauffage en céramique qui garantit une réduction des temps d'allumage de 40 %. Il est possible de gérer le poêle via le tableau de commande intégré, la télécommande (en option) ou un smartphone (avec un kit en option - Easy Connect).

→ Technical data p.186

En savoir plus sur la technologie:  
Find out more about the technology:  
**COMFORT AIR** p.034



**EN** — Ductable pellet stove with cast iron top and bordeaux, white, dark painted steel sides. Cast iron brazier. Top or rear outlet. Option of turning ventilation off completely. Product equipped with ceramic glow plug for 40% faster ignition times. You can choose to manage the stove via the built-in control panel, remote control (optional) or smartphone (optional kit - Easy Connect).



# Clio

**FR** — Poêle à pellets avec couvercle en fonte avec côtés en acier couleur Dark, Silver, Bordeaux, White. Produit hermétique, équipé d'une bougie d'allumage en céramique qui garantit des temps réduits de 40 %. Ventilation frontale. Il est possible de gérer le poêle via le tableau de commande intégré ou via un smartphone (avec un kit optionnel - Easy Connect).

**EN** — Pellet stove with cast iron top and steel sides in Dark, Silver, Bordeaux and White. Airtight product equipped with ceramic spark plug for 40% faster ignition times. Front ventilation. You can choose to manage the stove via the built-in control panel or smartphone (optional kit - Easy Connect).



→ Technical data p.186



Hera · Hera XUP!

150

MCZ PELLET — HERA / HERA XUP! Air 7



151

MCZ PELLET — HERA / HERA XUP! Air 7

## Hera · Hera XUP!



**FR** — Poêle à pellets avec couvercle en fonte et habillage en acier de couleur Dark, White, Silver ou Bronze. Brasier en fonte. Sortie supérieure supérieure (standard ou coaxiale) ou bien postérieure (avec un code différent). Possibilité de désactiver totalement la ventilation. Il est possible de gérer le poêle via le tableau de commande intégré, la télécommande (en option) ou via un smartphone (avec un kit en option - Easy Connect).

**EN** — Pellet stove made with cast iron top and Dark, White, Silver or Bronze cladding. Cast iron brazier. Top outlet (standard or coaxial) or rear outlet (dedicated product code). Option of turning ventilation off completely. You can choose to manage the stove via the built-in control panel, remote control (optional) or smartphone (optional kit - Easy Connect).

→ Technical data p.187



Alea · Alea XUP!



154

MCZ PELLET — ALEA / ALEA XUPI Air 7

155

MCZ PELLET — ALEA / ALEA XUPI Air 7

## Alea · Alea XUP!

**FR** — Poêle à pellets avec une profondeur réduite (28 cm) et avec une porte en fonte. Habillage en acier blanc, argent, noir ou bordeaux. Brasier et panneau arrière du foyer en fonte. Sortie des fumées supérieure ou arrière. Possibilité de désactiver totalement la ventilation. Il est possible de gérer le poêle via le tableau de commande intégré, la télécommande (en option) ou via un smartphone (avec un kit optionnel - Easy Connect).

**EN** — Slim pellet stove (28cm deep) with cast iron door. White, silver, black or burgundy steel cladding. Cast iron brazier and firebox back panel. Top or rear outlet. Option of turning ventilation off completely. You can choose to manage the stove via the built-in control panel, remote control (optional) or smartphone (optional kit - Easy Connect).

156

MCZ PELLET — ALEA / ALEA XUPI Air 7



→ Technical data p.187



157

MCZ PELLET — ALEA / ALEA XUPI Air 7





Raam · Raam UP! · Raam XUP!



## Raam · Raam UP! · Raam XUP!



**FR** — Poêle à pellets particulièrement adapté aux espaces étroits, grâce à sa profondeur réduite (29 cm). Habillage en métal de couleur White, Bordeaux, Black, Silver. Produit hermétique, équipé d'une bougie en céramique qui garantit une réduction des temps d'allumage de 40 %. Panneau de commande sur l'appareil. Possibilité de désactiver totalement la ventilation. Il est possible de gérer le poêle via le tableau de commande intégré, la télécommande (en option) ou via un smartphone (avec un kit optionnel - Easy Connect).

→ Technical data p.188

En savoir plus sur la technologie:  
Find out more about the technology:  
**COMFORT AIR** p.044



**EN** — Compact pellet stove (29cm deep) ideal for confined spaces. White, Bordeaux, Black, Silver metal cladding. Airtight product equipped with ceramic spark plug for 40% faster ignition times. Control panel on board the machine. Option of turning ventilation off completely. You can choose to manage the stove via the built-in control panel, remote control (optional) or smartphone (optional kit - Easy Connect).

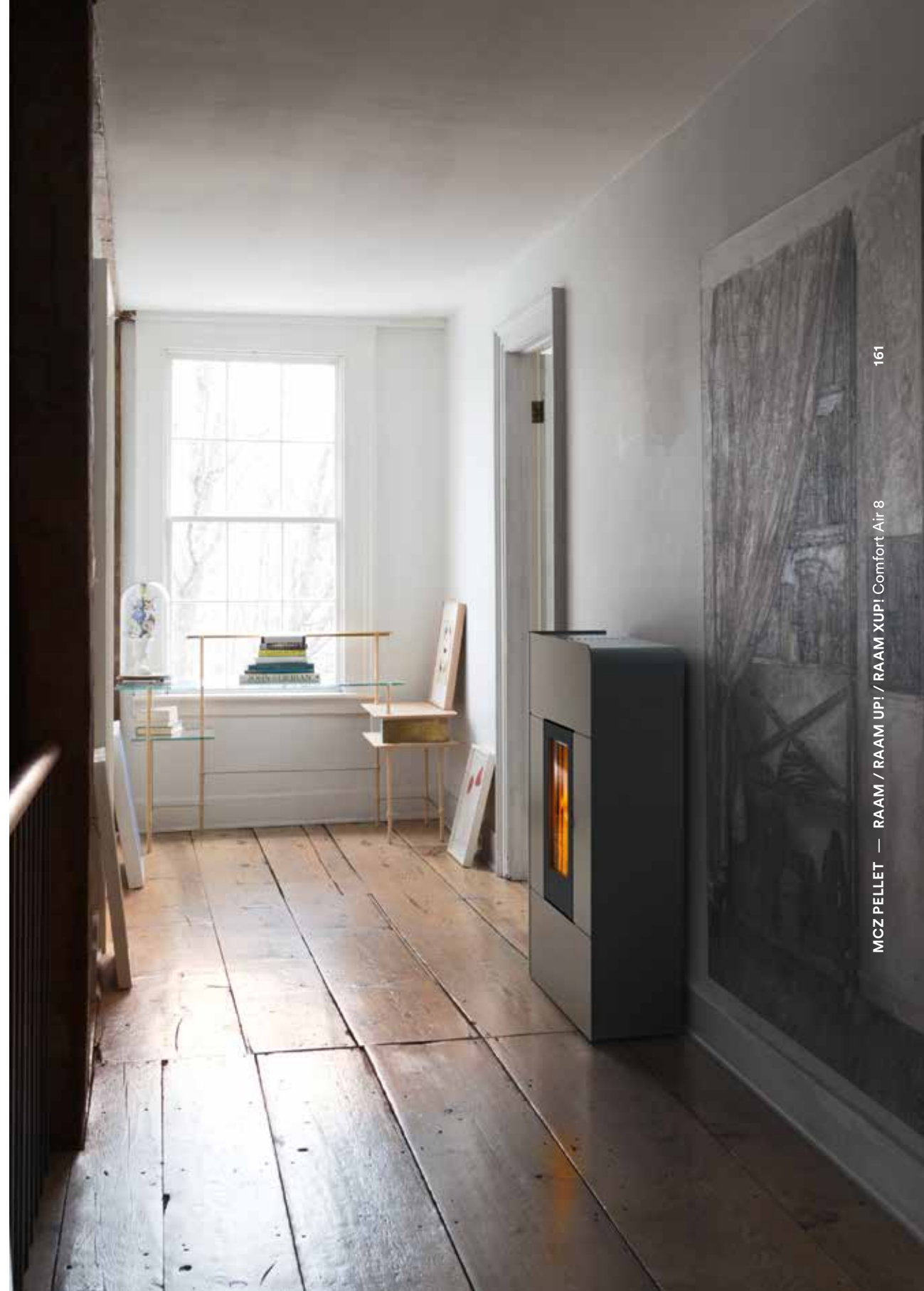

# Thea



**FR** — Poêle à pellets hydro avec côtés en acier couleur Dark, Bordeaux, White. Produit équipé d'une bougie en céramique qui garantit une réduction des temps d'allumage de 40 %. Ventilation frontale. Évacuation arrière et supérieure. Il est possible de gérer le poêle via le tableau de commande intégré ou via un smartphone (avec un kit optionnel - Easy Connect).

**EN** — Hydro pellet stove with steel sides in Dark, Silver, Burgundy and White. Product equipped with ceramic glow plug for 40% faster ignition times. Front ventilation. Rear and top outlet. You can choose to manage the stove via the built-in control panel or smartphone (optional kit - Easy Connect).

→ Technical data p.188



## Sommaire / Summary table



### BRUSHLESS

**FR** — Grâce à une technologie avancée, le nouveau motoréducteur sans balais garantit un grand confort acoustique (niveaux de bruit pratiquement nuls) et une économie d'énergie considérable (réduction des consommations de 90 % par rapport aux moteurs traditionnels). Utilisé aussi bien dans le système de chargement des pellets que dans celui de nettoyage automatique du brasier (versions Hydro Matic et Comfort Air Matic).

**EN** — Thanks to advanced technology, the new brushless gear motor guarantees high sound comfort (almost no noise) and substantial energy savings (consumption 90% lower compared to traditional motors). Used both in the pellet loading system and in the automatic brazier cleaning system (Hydro Matic and Comfort Air Matic systems).



### KIT X-UP

**FR** — Solution pour installer le poêle avec des raccords coaxiaux, typiques des maisons passives ou à faible consommation d'énergie dans deux applications : au mur\* ou au plafond\*\*. Permet de positionner le poêle à seulement quelques centimètres du mur. Ce kit est réalisé en acier de grande épaisseur (couleur noire) et peut être adapté aux versions UP de Ego, Star, Suite, Club et Musa. Il est compatible avec tous les formats 80 mm/130 mm et peut être utilisé avec différents tubes coaxiaux en utilisant l'adaptateur fourni par les divers fournisseurs de conduits. (\* zone 3 France / \*\* zone 2 France).

**EN** — Solution to install the stove with coaxial connectors, which are typical of passive or low energy consumption homes with two applications: wall or ceiling. It allows you to place the stove just a few centimeters from the wall. It is a kit made of thick steel (in black), which can be adapted to the UP versions of Ego, Star, Suite, Club and Musa. It is compatible with all 80 mm/130 mm formats and can be used with different coaxial cables by means of an adapter supplied by the pipe manufacturer.



### QUICKSTART

**FR** — Produit équipé d'une bougie d'allumage en céramique qui garantit des temps réduits de 40 %.

**EN** — Product equipped with ceramic spark plug ensuring ignition times reduced by 40%.



### OYSTER

**FR** — Grâce à une structure parfaitement étanche, tous les poêles ne consomment pas l'oxygène de la pièce, prenant tout l'air à l'extérieur, et ils peuvent donc être installés dans toutes les maisons bien isolées et à l'intérieur des maisons passives.

**EN** — Thanks to a perfectly sealed structure, all the stoves do not use up the oxygen inside the room. Instead, they draw air from the outside environment and can therefore be fitted in all well-insulated homes and in passive homes as well.

164

165

MCZ PELLETT — SOMMAIRE / SUMMARY TABLE

MCZ PELLETT — SOMMAIRE / SUMMARY TABLE



### VIDAGE DES CENDRES HEBDOMADAIRE — WEEKLY ASH EMPTYING

**FR** — La très grande capacité du tiroir à cendres permet une utilisation du poêle allant jusqu'à une semaine sans besoin de vider le cendrier, et jusqu'à plus d'une semaine pour des puissances supérieures (consommation à puissance moyenne, fonctionnement pendant 8 heures/jour).

**EN** — The high capacity of the ash pan allows to use the heater without emptying up to one week for low power and over a week for higher powers (average power consumption, 8 hours / day operation).



### DÉSACTIVATION DE LA VENTILATION — VENTILATION EXCLUDABLE

**FR** — Sur les poêles avec ventilation, la fonction No-Air permet d'exclure complètement\*\* la ventilation forcée du poêle – ou de la limiter au minimum –, garantissant ainsi le plus grand silence et tout le plaisir de la chaleur diffusée dans la pièce par convection naturelle.

**EN** — The No air function in ventilated heaters, allows to totally exclude\*\* or to minimally reduce the forced ventilation of the heater, thus ensuring the utmost silence and all the pleasure of heat spread out in the environment by natural convection.

\*\* Ego (Air-Comfort Air), Star (Air-Comfort Air), Musa Air, Suite Air, Club Air, Wall, Loop, Curve, Berg, Mood, Halo, Flow, Aike, Klin, Tilda, Alea, Deco, Cute, Thema, Tecla, Alyssa, May, Hera, Gio', Maggie.



### BRASIER AUTONETTOYANT — SELF-CLEANING BRAZIE

**FR** — Brasier autonettoyant à raclement mécanique géré automatiquement par l'électronique du poêle.

**EN** — Self-cleaning brazier with mechanical scraping, managed automatically by the electronics of the stove.



### FLAMME NATURELLE — NATURAL FLAME

**FR** — Les produits à pellets sont caractérisés par une flamme ample au mouvement plus naturel, vraiment belle à admirer.

**EN** — Pellet products feature a large flame with a more natural movement and truly beautiful to look at.



### WI-FI DE SÉRIE — WI-FI SUPPLIED AS STANDARD

**FR** — Gestion e configuration à distance.

**EN** — Remote management and programming.



### POSSIBILITÉ D'INSTALLATION AVEC ÉVACUATION SUPÉRIEURE OU À L'ARRIÈRE — POSSIBILITY OF INSTALLATION WITH TOP OR REAR OUTLET

**FR** — Tous les nouveaux produits sont disponibles en deux versions, avec une évacuation arrière traditionnelle, ou avec une évacuation supérieure centrale. C'est à vous de choisir.

**EN** — All new products are available in two versions, with traditional rear outlet or central top outlet. Whichever you prefer.



### CONDUIT D'ÉVACUATION DE FUMÉES COAXIAL DE SÉRIE — COAXIAL SMOKE OUTLET INCLUDED AS STANDARD

**DONNÉES  
TECHNIQUES  
— TECHNICAL  
DATA**

169	<b>Vivo Maestro 90</b>
	<b>Comfort Air</b>
171	<b>Vivo Maestro 90 Hydro</b>
173	<b>Boxtherm Maestro</b>
174	<b>Mako</b>
174	<b>Wall · Wall UP!</b>
175	<b>Wall Angle</b>
175	<b>Loop</b>
176	<b>Berg</b>
176	<b>Mood</b>
177	<b>Halo · Halo UP!</b>
177	<b>Curve</b>
178	<b>Flow</b>

181	<b>Alyssa</b>
182	<b>Tecla</b>
182	<b>Pad</b>
183	<b>Jazz</b>
183	<b>Decò</b>
184	<b>Cute</b>
184	<b>May</b>
185	<b>Ghea · Ghea XUP!</b>
185	<b>Mida · Mida XUP!</b>
186	<b>Teia · Teia UP!</b>
186	<b>Clio</b>
187	<b>Hera · Hera XUP!</b>
187	<b>Alea · Alea XUP!</b>
188	<b>Raam · Raam UP!</b>
	<b>Raam XUP!</b>
188	<b>Thea</b>
189	<b>Sahara</b>

178	<b>Reflex</b>
179	<b>Ray · Ray UP! · Ray XUP!</b>
179	<b>Doc · Doc UP!</b>
180	<b>Stream · Stream UP!</b>
180	<b>Philo · Philo UP!</b>
181	<b>Aki</b>

190	<b>Ego · Ego UP! · Ego XUP!</b>
192	<b>Star · Star UP!</b>
194	<b>Suite · Suite UP!</b>
196	<b>Club · Club UP!</b>
198	<b>Musa · Musa UP!</b>

## Vivo Maestro 90 Comfort Air

**FR** — Cheminée à pellets panoramique pouvant être combinée aux systèmes de canalisation de l'air pour chauffer plusieurs pièces même s'ils ne communiquent pas. Le brasier et le foyer sont en fonte noire. Produit équipé d'une bougie en céramique qui garantit une réduction des temps d'allumage de 40 %. Cette cheminée peut être installée à proximité du sol. Chargement ergonomique des pellets. Ce produit offre plusieurs options d'utilisation. On peut choisir d'utiliser son smartphone, à la maison et à l'extérieur, ou de gérer le poêle à la maison via la télécommande « freestanding » avec thermostat d'ambiance (en option) ou via le panneau de contrôle (en option).

**EN** — Pellet fireplace with a large view, which can be combined with air ducting systems to heat several rooms, even non-communicating ones. Black cast iron brazier and firebox. Product equipped with ceramic glow plug ensuring ignition times reduced by 40%. This fireplace can be installed close to the floor. Ergonomic pellet loading. This product offers several application options. You can choose to use your smartphone, both when at home and away, or to control the stove at home with the (optional) freestanding remote control with room thermostat or the (optional) control panel.

168

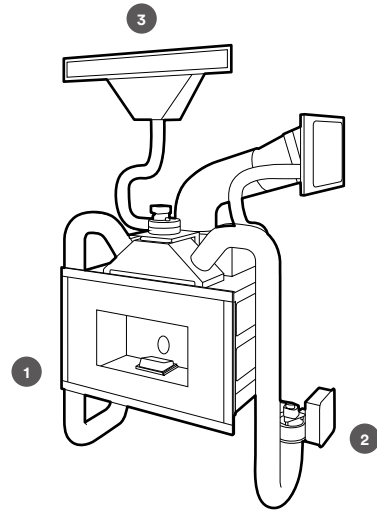

11 kW

**3 Canalisations**  
— 3 Ducts

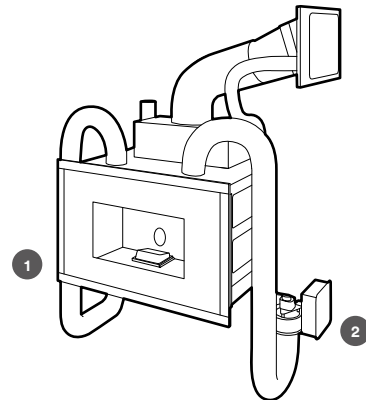

9 kW

**2 Canalisations**  
— 2 Ducts

## Vivo Maestro 90 9 / p. 124

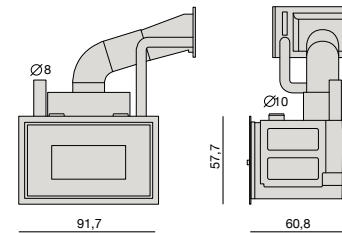

**COMFORT AIR 9 kW**  
Model: VIVO 90 COMFORT AIR 9 M1

8,8 - 7.568 [kW-kcal/h]

2,7 - 2.322 [kW-kcal/h]

91 / 92,5 [%]

65 (con tubo) [l]

pellet Ø 6 x 3÷40 [mm]

~ 0,6 / ~ 2,5 [kg/h]

65 / 19 [h]

162/55 - 254/35 - 445/20 [m³] \*

8 [cm]

120 [kg]

140 [°C]

6 [g/s]

CE

EN 14785

BlmSchV Stufe 2

ART. 15a B-VG 2015

REGENSBURGER/

AACHENER/

MÜNCHENER BStV

LRV



Conto Termico 2.0



A+

## Vivo Maestro 90 11 / p. 124

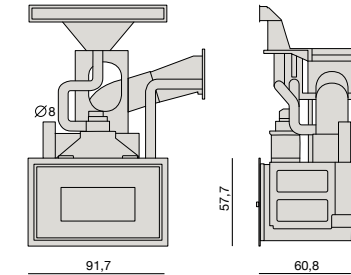

**COMFORT AIR 11 kW**  
Model: VIVO 90 COMFORT AIR 11 M1

10,9 - 9.374 [kW-kcal/h]

2,7 - 2.322 [kW-kcal/h]

90,5 / 92,5 [%]

65 (con tubo) [l]

pellet Ø 6 x 3÷40 [mm]

~ 0,6 / ~ 2,5 [kg/h]

65 / 16 [h]

198/55 - 311/35 - 545/20 [m³] \*

8 [cm]

140 [kg]

170 [°C]

7 [g/s]

CE

EN 14785

BlmSchV Stufe 2

ART. 15a B-VG 2015

REGENSBURGER/

AACHENER/

MÜNCHENER BStV

LRV



Conto Termico 2.0



A+

169

POWER max

POWER min



**FR** — Gestion automatique et programmable. (Chrono-thermostat sans fil en option pour la gestion de la température ambiante). De la chaleur dans toute la maison avec les radiateurs déjà existants. Nouvelle version en format panoramique et technologie Maestro.

**EN** — Automatic and programmable management (optional wireless timed thermostat for room temperature control). Heat throughout the home using existing radiators. New version with large view and Maestro technology.

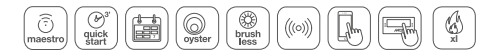
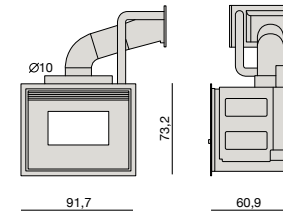
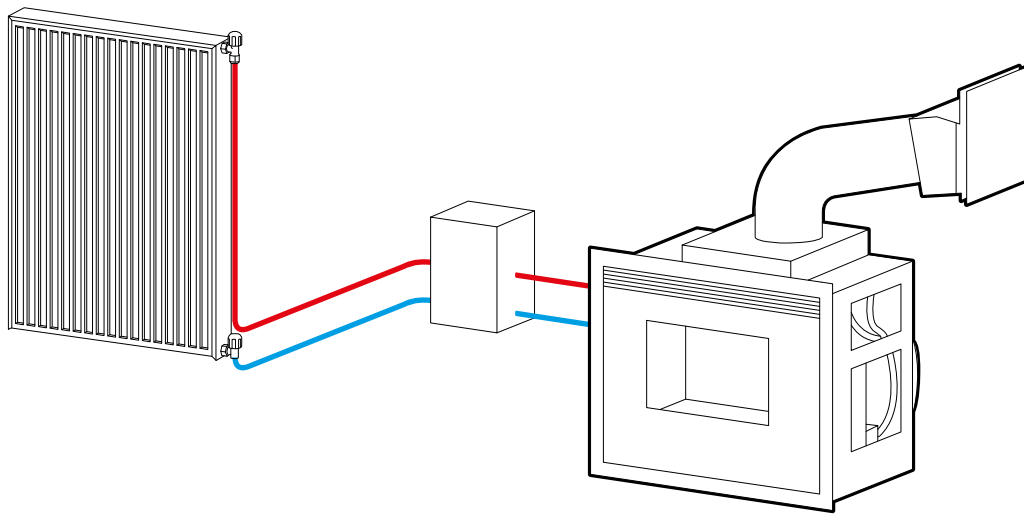

<b>HYDRO 16</b> Model: VIVO 90 HYDRO 16 M1	<b>HYDRO 24</b> Model: VIVO 90 HYDRO 24 M1
18-15.487 [kW-kcal/h] water 13-11.185	24,7-21.252 [kW-kcal/h] water 19-16.348
4,7-4.042 [kW-kcal/h] water 3,1-2.866	4,7-4.042 [kW-kcal/h] water 3,1-2.866
94,2 / 95,9 [%]	93,3 / 95,9 [%]
64 [l]	64 [l]
pellet Ø 6 x 3÷40 [mm]	pellet Ø 6 x 3÷40 [mm]
~ 1,2 / ~ 3,95 [kg/h]	~ 1,2 / ~ 5,5 [kg/h]
~ 45 / ~ 13 [h]	~ 45 / ~ 9 [h]
327/55 - 514/35 - 900/20 [m³] *	449/55 - 706/35 - 1235/20 [m³] *
8 [cm]	8 [cm]
190 [kg]	190 [kg]
120 [°C]	165 [°C]
9 [g/s]	14 [g/s]

**CE**

EN 14785  
BlmSchV Stufe 2  
ART. 15a B-VG 2015  
REGENSBURGER/  
AACHENER/  
MÜNCHENER BStV  
LRV



Conto Termico 2.0



**A++**

## Boxtherm Maestro

**FR** — Insert à pellets avec fonction de désactivation de la ventilation. Ce produit offre plusieurs options d'utilisation. On peut choisir d'utiliser son smartphone, à la maison et à l'extérieur, ou de gérer le poêle à la maison via la télécommande « freestanding » avec thermostat d'ambiance (en option) ou via le panneau de contrôle (en option).

**EN** — Pellet insert with ventilation exclusion function. This product offers several application options. You can choose to use your smartphone, both when at home and away, or to control the stove at home with the (optional) freestanding remote control with room thermostat or the (optional) control panel.

### BASIC

**Chargement frontal par tiroir intégré.**  
— Front loading via a built-in drawer.

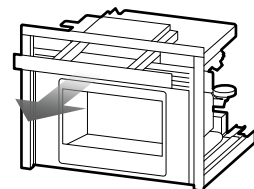

### SLIDE

**Chargement par extraction totale.**  
— Loaded via a full extraction system.

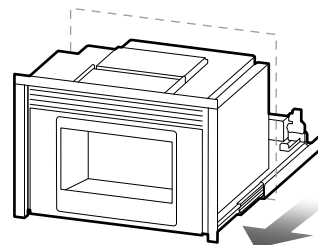

### KIT LINK

**Chargement par une porte dans la hotte.**  
— Loading via the door in the hood.

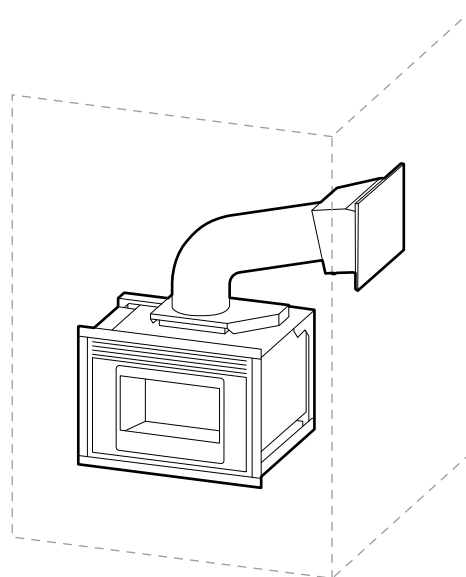

## Boxtherm Maestro 60 / p. 128

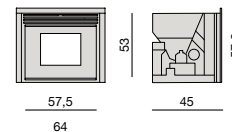

### AIR

Model: BOXTHERM 60 AIR 6 BASIC M1  
Model: BOXTHERM 60 AIR 6 SLIDE M1

5,9 - 5.074 [kW-kcal/h]

2,2 - 1.892 [kW-kcal/h]

91,0 / 94,7 [%]

13 [l]

pellet Ø 6 x 3÷40 [mm]

~ 0,5 / ~ 1,3 [kg/h]

~ 17 / ~ 7 [h]

107/55 - 169/35 - 295/20 [m³] \*

8 [cm]

135 [kg]

167 [°C]

4,0 [g/s]

CE

EN 14785

BlmSchV Stufe 2

ART. 15a B-VG 2015

REGENSBURGER/

AACHENER/

MÜNCHENER BStV

LRV



Conto Termico 2.0



## Boxtherm Maestro 70 / p. 128

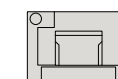
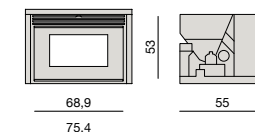

### AIR

Model: BOXTHERM 70 AIR 9 BASIC M1  
Model: BOXTHERM 70 AIR 9 SLIDE M1

8,8 - 7.568 [kW-kcal/h]

2,5 - 2.150 [kW-kcal/h]

90,6 / 94,1 [%]

20 [l]

pellet Ø 6 x 3÷40 [mm]

~ 0,6 / ~ 2,0 [kg/h]

~ 21 / ~ 6 [h]

160/55 - 251/35 - 440/20 [m³] \*

8 [cm]

135 [kg]

188 [°C]

5,0 [g/s]

CE

EN 14785

BlmSchV Stufe 2

ART. 15a B-VG 2015

REGENSBURGER/

AACHENER/

MÜNCHENER BStV

LRV



Conto Termico 2.0





# Mako / p. 010

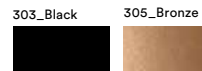
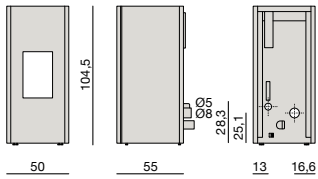

## CORE COMFORT AIR MATIC

Model: MAKO COMFORT AIRMATIC 8 M1

**8 - 6.880 [kW-kcal/h]**

**2,5 - 2.150 [kW-kcal/h]**

**90,4 / 92,9 [%]**

**44 [l]**

**pellet Ø 6 x 3÷40 [mm]**

**~ 0,6 / ~ 1,9 [kg/h]**

**~ 48 / ~ 15 [h]**

**145/55 - 229/35 - 400/20 [m³] \***

**8 [cm]**

**161 [kg]**

**167 [°C]**

**3,1 - 5,4 [g/s]**



EN 14785  
BlmSchV Stufe 2  
ART. 15a B-VG 2015  
REGENSBURGER/  
AACHENER/  
MÜNCHENER BStV  
LRV



# Wall·Wall UP! / p. 024



REAR



UP!

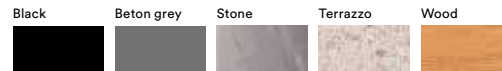
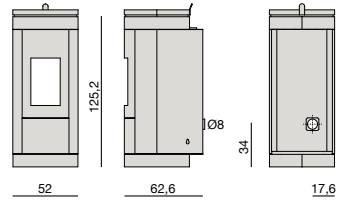

## AIR

Model: WALL AIR 8 M1

**8,1 - 6.966 [kW-kcal/h]**

**2,3 - 1.978 [kW-kcal/h]**

**90,9 / 92,6 [%]**

**32 [l]**

**pellet Ø 6 x 3÷40 [mm]**

**~ 0,5 / ~ 1,8 [kg/h]**

**~ 40 / ~ 11 [h]**

**147/55 - 231/35 - 405/20 [m³] \***

**8 [cm]**

**132 [kg]**

**188 [°C]**

**4,3 [g/s]**



EN 14785  
BlmSchV Stufe 2  
ART. 15a B-VG 2015  
REGENSBURGER/  
AACHENER/  
MÜNCHENER BStV  
LRV



## AIR UP!

Model: WALL AIR 8 UP! M1

**8,1 - 6.966 [kW-kcal/h]**

**2,3 - 1.978 [kW-kcal/h]**

**90,9 / 92,6 [%]**

**27 [l]**

**pellet Ø 6 x 3÷40 [mm]**

**~ 0,5 / ~ 1,8 [kg/h]**

**~ 35 / ~ 10 [h]**

**147/55 - 231/35 - 405/20 [m³] \***

**8 [cm]**

**136 [kg]**

**188 [°C]**

**4,3 [g/s]**

# Wall Angle / p. 024

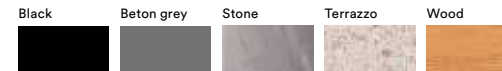
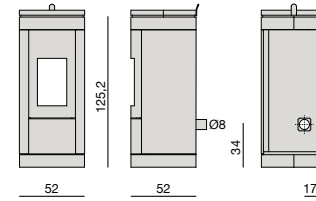

## AIR

Model: WALL ANGLE AIR 8 M1

**8,1 - 6.966 [kW-kcal/h]**

**2,3 - 1.978 [kW-kcal/h]**

**90,9 / 92,6 [%]**

**32 [l]**

**pellet Ø 6 x 3÷40 [mm]**

**~ 0,5 / ~ 1,8 [kg/h]**

**~ 40 / ~ 11 [h]**

**147/55 - 231/35 - 405/20 [m³] \***

**8 [cm]**

**129 [kg]**

**188 [°C]**

**4,3 [g/s]**



EN 14785  
BlmSchV Stufe 2  
ART. 15a B-VG 2015  
REGENSBURGER/  
AACHENER/  
MÜNCHENER BStV  
LRV



# Loop / p. 026

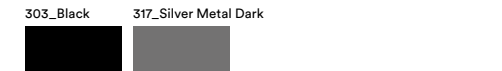
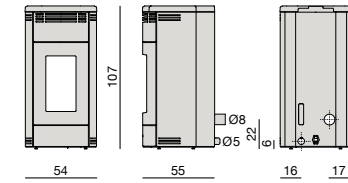

## AIR

Model: LOOP AIR 8 M1

**8,0 - 6.880 [kW-kcal/h]**

**2,5 - 2.150 [kW-kcal/h]**

**90,4 / 92,0 [%]**

**32 [l]**

**pellet Ø 6 x 3÷40 [mm]**

**~ 0,6 / ~ 1,8 [kg/h]**

**~ 35 / ~ 12 [h]**

**145/55 - 229/35 - 400/20 [m³] \***

**8 [cm]**

**140 [kg]**

**196 [°C]**

**4,3 [g/s]**



EN 14785  
BlmSchV Stufe 2  
ART. 15a B-VG 2015  
REGENSBURGER/  
AACHENER/  
MÜNCHENER BStV  
LRV





**Flow /** p. 050

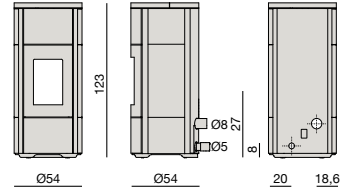

102\_Plain White 107\_Plain Black 102\_Line White 105\_Line Bordeaux



**COMFORT AIR**  
Model: FLOW COMFORT AIR 10 M1

10 - 8.600 [kW-kcal/h]

2,3 - 1.978 [kW-kcal/h]

90,4 / 92,6 [%]

39 [l]

pellet Ø 6 x 3÷40 [mm]

~ 0,5 / ~ 2,3 [kg/h]

~ 50 / ~ 11 [h]

182/55 - 286/35 - 500/20 [m³] \*

8 [cm]

130 [kg]

212 [°C]

5,0 [g/s]

CE

EN 14785  
BlmSchV Stufe 2  
ART. 15a B-VG 2015  
REGENSBURGER/  
AACHENER/  
MÜNCHENER BStV  
LRV



**Reflex /** p. 054

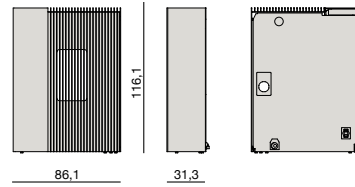

303\_Black 303\_Black / 321\_Gold 303\_Black / 305\_Bronze



**COMFORT AIR UP!**  
Model: REFLEX COMFORT AIR 8 UP! M1

7,8 - 6.708 [kW-kcal/h]

2,3 - 1.978 [kW-kcal/h]

90,2 / 91,5 [%]

28 [l]

pellet Ø 6 x 3÷40 [mm]

~ 0,5 / ~ 1,7 [kg/h]

~ 36 / ~ 11 [h]

142/55 - 223/35 - 390/20 [m³] \*

8 [cm]

155 [kg]

179 [°C]

4,7 [g/s]

CE

EN 14785  
BlmSchV Stufe 2  
ART. 15a B-VG 2015  
REGENSBURGER/  
AACHENER/  
MÜNCHENER BStV  
LRV



**Ray · Ray UP! · Ray XUP! /** p. 058

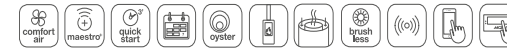
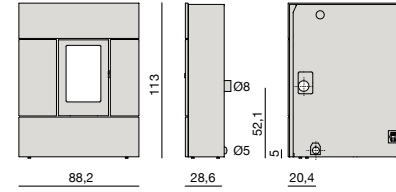

102\_W 107\_B 105\_B 240\_S 302\_W 308\_D 304\_B



**COMFORT AIR** Model: RAY COMFORT AIR 8 M1  
**COMFORT AIR UP!** Model: RAY COMFORT AIR 8 UP! M1

7,8 - 6.708 [kW-kcal/h] 7,8 - 6.708 [kW-kcal/h]

2,3 - 1.978 [kW-kcal/h] 2,3 - 1.978 [kW-kcal/h]

90,2 / 91,5 [%] 90,2 / 91,5 [%]

28 [l] 28 [l]

pellet Ø 6 x 3÷40 [mm] pellet Ø 6 x 3÷40 [mm]

~ 0,5 / ~ 1,7 [kg/h] ~ 0,5 / ~ 1,7 [kg/h]

~ 36 / ~ 11 [h] ~ 36 / ~ 11 [h]

142/55 - 223/35 - 390/20 [m³] \* 142/55 - 223/35 - 390/20 [m³] \*

8 [cm] 8 [cm]

155 [kg] 155 [kg]

179 [°C] 179 [°C]

4,7 [g/s] 4,7 [g/s]

CE

EN 14785  
BlmSchV Stufe 2  
ART. 15a B-VG 2015  
REGENSBURGER/  
AACHENER/  
MÜNCHENER BStV  
LRV



**Doc · Doc UP! /** p. 064

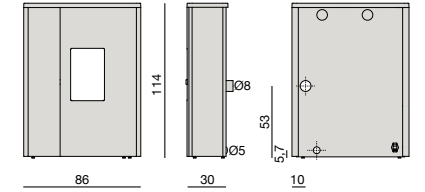

303\_Black 315\_Aluminium



**COMFORT AIR** Model: DOC COMFORT AIR 9 M1  
**COMFORT AIR UP!** Model: DOC COMFORT AIR 9 UP! M1

8,8 - 7.568 [kW-kcal/h] 8,8 - 7.568 [kW-kcal/h]

2,6 - 2.236 [kW-kcal/h] 2,6 - 2.236 [kW-kcal/h]

90,9 / 89,8 [%] 90,9 / 89,8 [%]

18 [l] 18 [l]

pellet Ø 6 x 3÷40 [mm] pellet Ø 6 x 3÷40 [mm]

~ 0,6 / ~ 1,9 [kg/h] ~ 0,6 / ~ 1,9 [kg/h]

~ 20 / ~ 6 [h] ~ 20 / ~ 6 [h]

160/55 - 251/35 - 440/20 [m³] \* 160/55 - 251/35 - 440/20 [m³] \*

8 [cm] 8 [cm]

148 [kg] 148 [kg]

186 [°C] 186 [°C]

4,7 [g/s] 4,7 [g/s]

CE

EN 14785  
BlmSchV Stufe 2  
ART. 15a B-VG 2015  
REGENSBURGER/  
AACHENER/  
MÜNCHENER BStV  
LRV



# Stream · Stream UP! / p. 066

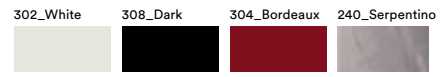
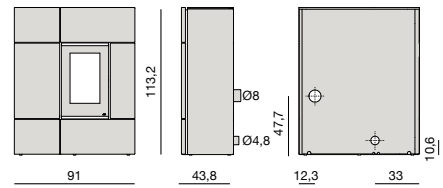

**COMFORT AIR 12** Model: STREAM COMFORT AIR 12 M1  
**COMFORT AIR 12 UP!** Model: STREAM COMFORT AIR 12 UP! M1

POWER max	11,9 - 10.234 [kW-kcal/h]	11,9 - 10.234 [kW-kcal/h]
POWER min	3,4 - 2.924 [kW-kcal/h]	3,4 - 2.924 [kW-kcal/h]
%	90,8 / 93,2 [%]	90,8 / 93,2 [%]
Wind	42 [l]	42 [l]
Pellet	pellet Ø 6 x 3÷40 [mm]	pellet Ø 6 x 3÷40 [mm]
Weight	~ 0,8 / ~ 2,7 [kg/h]	~ 0,8 / ~ 2,7 [kg/h]
Volume	~ 34 / ~ 10 [h]	~ 34 / ~ 10 [h]
Capacity	216/55 - 340/35 - 595/20 [m³] *	216/55 - 340/35 - 595/20 [m³] *
Height	8 [cm]	8 [cm]
Weight	180 [kg]	180 [kg]
Temp	193 [°C]	193 [°C]
Flow	6,4 [g/s]	6,4 [g/s]

CE EN 14785 BlmSchV Stufe 2 ART. 15a B-VG 2015 REGENSBURGER/AACHENER/MÜNCHENER BStV LRV

# Philo · Philo UP! / p. 070

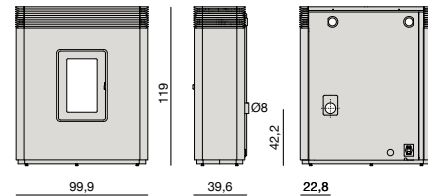

**COMFORT AIR 14** Model: PHILO COMFORT AIR 14 M1  
**COMFORT AIR 14 UP!** Model: PHILO COMFORT AIR 14 UP! M1

POWER max	13,8 - 11.868 [kW-kcal/h]	13,8 - 11.868 [kW-kcal/h]
POWER min	3,4 - 2.924 [kW-kcal/h]	3,4 - 2.924 [kW-kcal/h]
%	90,5 / 93,2 [%]	90,5 / 93,2 [%]
Wind	30 [l]	30 [l]
Pellet	pellet Ø 6 x 3÷40 [mm]	pellet Ø 6 x 3÷40 [mm]
Weight	~ 0,8 / ~ 3,1 [kg/h]	~ 0,8 / ~ 3,1 [kg/h]
Volume	~ 25 / ~ 7,0 [h]	~ 25 / ~ 7,0 [h]
Capacity	251/55 - 394/35 - 690/20 [m³] *	251/55 - 394/35 - 690/20 [m³] *
Height	8 [cm]	8 [cm]
Weight	200 [kg]	200 [kg]
Temp	205 [°C]	205 [°C]
Flow	7,1 [g/s]	7,1 [g/s]

CE EN 14785 BlmSchV Stufe 2 ART. 15a B-VG 2015 REGENSBURGER/AACHENER/MÜNCHENER BStV LRV

# Aki / p. 074

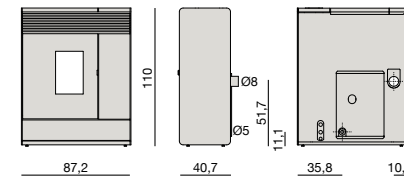

**HYDRO MATIC 18** Model: AKI HYDRO MATIC 18 M2  
**HYDRO MATIC 24** Model: AKI HYDRO MATIC 24 M2

POWER max	17,7 - 15.222 [kW-kcal/h] water 12,7 - 10.922	24,2 - 20.812 [kW-kcal/h] water 18,2 - 15.652
POWER min	4,4 - 3.784 [kW-kcal/h] water 2,3 - 1.978	4,4 - 3.784 [kW-kcal/h] water 2,3 - 1.978
%	92,9/95,9 [%]	92,9/95,9 [%]
Wind	43 [l]	43 [l]
Pellet	pellet Ø 6 x 3÷40 [mm]	pellet Ø 6 x 3÷40 [mm]
Weight	~ 1 / ~ 3,9 [kg/h]	~ 1 / ~ 5,4 [kg/h]
Volume	~ 28 / ~ 7 [h]	~ 28 / ~ 5 [h]
Capacity	322/55 - 506/35 - 885/20 [m³] *	440/55 - 691/35 - 1210/20 [m³] *
Height	8 [cm]	8 [cm]
Weight	190 [kg]	190 [kg]
Temp	107 [°C]	143 [°C]
Flow	10,6 [g/s]	14,2 [g/s]

CE EN 14785 BlmSchV Stufe 2 ART. 15a B-VG 2015 REGENSBURGER/AACHENER/MÜNCHENER BStV LRV

# Alyssa / p. 078

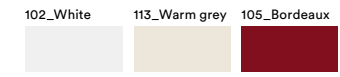
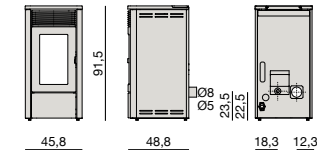

**AIR** Model: ALYSSA AIR 6 M1

POWER max	6,3 - 5.418 [kW-kcal/h]
POWER min	2,5 - 2.150 [kW-kcal/h]
%	91,5 / 92,0 [%]
Wind	24 [l]
Pellet	pellet Ø 6 x 3÷40 [mm]
Weight	~ 0,6 / ~ 1,45 [kg/h]
Volume	~ 26 / ~ 11 [h]
Capacity	115/55 - 180/35 - 315/20 [m³] *
Height	8 [cm]
Weight	90 [kg]
Temp	165 [°C]
Flow	3,7 [g/s]

CE EN 14785 BlmSchV Stufe 2 ART. 15a B-VG 2015 REGENSBURGER/AACHENER/MÜNCHENER BStV LRV

# Tecla / p. 080

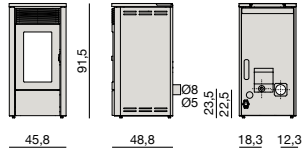

302\_White 313\_Silver 308\_Dark 304\_Bordeaux



**AIR**  
Model: TECLA AIR 6 M1

6,3 - 5.418 [kW-kcal/h]

2,5 - 2.150 [kW-kcal/h]

91,5 / 92,0 [%]

24 [l]

pellet Ø 6 x 3÷40 [mm]

~ 0,6 / ~ 1,45 [kg/h]

~ 26 / ~ 11 [h]

115/55 - 180/35 - 315/20 [m³] \*

8 [cm]

90 [kg]

165 [°C]

3,7 [g/s]

CE

EN 14785

BlmSchV Stufe 2

ART. 15a B-VG 2015

REGENSBURGER/  
AACHENER/  
MÜNCHENER BSTV

LRV



Conto Termico 2.0

# Pad / p. 106

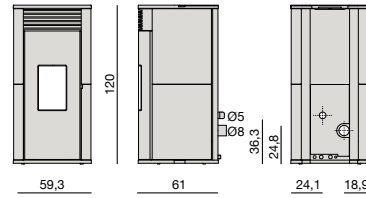

102\_Plain White 107\_Plain Black 102\_Line White 105\_Line Bordeaux



**HYDRO MATIC 18**  
Model: PAD HYDROMATIC 18 M2

17,7-15.222 [kW-kcal/h]  
water 12,7-10.992

4,4-3.870 [kW-kcal/h]  
water 2,3-1.978

94,8 / 95,9[%]

38 [l]

pellet Ø 6 x 3÷40 [mm]

~ 1 / ~ 3,5 [kg/h]

~ 26 / ~ 8 [h]

322/55 - 506/35 -  
885/20 [m³] \*

8 [cm]

190 [kg]

118 [°C]

9,1 [g/s]

CE

EN 14785

BlmSchV Stufe 2

ART. 15a B-VG 2015

REGENSBURGER/  
AACHENER/  
MÜNCHENER BSTV

LRV



Conto Termico 2.0  
BAFA

# Jazz / p. 112

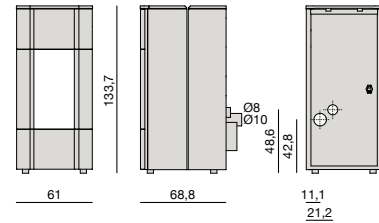

102\_White 107\_Black 105\_Bordeaux



**HYDRO MATIC 30**  
Model: JAZZ HYDRO MATIC 30 M1

28,5 - 24.510 [kW-kcal/h]  
water 27,1 - 23.306

7,6 - 6.536 [kW-kcal/h]  
water 6,6 - 5.676

93,4 / 94,4 [%]

72 [l]

pellet Ø 6 x 3÷40 [mm]

~ 1,7 / ~ 6,3 [kg/h]

~ 28 / ~ 7 [h]

518/55 - 814/35 -  
1425/20 [m³] \*

10 [cm]

292 [kg]

105 [°C]

20,7 [g/s]

CE

EN 14785

BlmSchV Stufe 2

ART. 15a B-VG 2015

REGENSBURGER/  
AACHENER/  
MÜNCHENER BSTV

LRV



Conto Termico 2.0  
BAFA

# Decò / p. 118



REAR



UP!

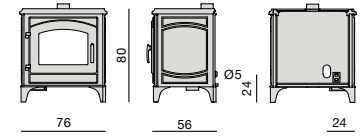

501\_Smoke



**AIR**  
Model: DECÒ AIR 8 M1

8,0 - 6.880 [kW-kcal/h]

2,4 - 2.064 [kW-kcal/h]

92,7 / 94,3 [%]

20 [l]

pellet Ø 6 x 3÷40 [mm]

~ 0,5 / ~ 1,85 [kg/h]

~ 15 / ~ 7 [h]

145/55 - 229/35 - 400/20 [m³] \*

10/8 [cm]

185 [kg]

135 [°C]

4,8 [g/s]

CE

EN 14785

BlmSchV Stufe 2

ART. 15a B-VG 2015

REGENSBURGER/  
AACHENER/  
MÜNCHENER BSTV

LRV



Conto Termico 2.0



# Teia · Teia UP! / p. 144

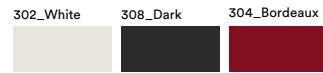
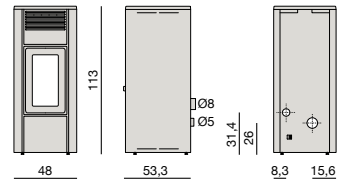

## COMFORT AIR Model: TEIA COMFORT AIR 10 S1

## COMFORT AIR UP! Model: TEIA COMFORT AIR 10 UP! S1

10,0 – 8.600 [kW-kcal/h]

10,0 – 8.600 [kW-kcal/h]

2,3 – 1.978 [kW-kcal/h]

2,3 – 1.978 [kW-kcal/h]

90,4 / 92,6 [%]

90,4 / 92,6 [%]

42 [l]

38 [l]

pellet Ø 6 x 3÷40 [mm]

pellet Ø 6 x 3÷40 [mm]

~ 0,5 / ~ 2,3 [kg/h]

~ 0,5 / ~ 2,3 [kg/h]

~ 54 / ~ 12 [h]

~ 50 / ~ 11 [h]

182/55 - 286/35 - 500/20 [m³] \*

182/55 - 286/35 - 500/20 [m³] \*

8 [cm]

8 [cm]

132 [kg]

135 [kg]

212 [°C]

212 [°C]

2,7 - 5,0 [g/s]

2,7 - 5,0 [g/s]



# Clio / p. 148

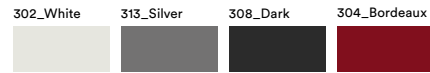
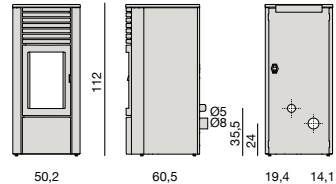

## HYDRO 16 Model: CLIO HYDRO 16

## HYDRO 23 Model: CLIO HYDRO 23

16,2-13.932 [kW-kcal/h] water 12,9-11.094

22,8-19.608 [kW-kcal/h] water 18,7-16.082

4,7-4.042 [kW-kcal/h] water 3,1-2.666

4,7-4.042 [kW-kcal/h] water 3,1-2.666

93,3 / 96,5 [%]

91,3 / 96,5 [%]

40 [l]

40 [l]

pellet Ø 6 x 3÷40 [mm]

pellet Ø 6 x 3÷40 [mm]

~ 1,0 / ~ 3,5 [kg/h]

~ 1,0 / ~ 5,0 [kg/h]

~ 26 / ~ 8 [h]

~ 26 / ~ 5 [h]

295/55 - 463/35 - 810/20 [m³] \*

415/55 - 651/35 - 1140/20 [m³] \*

8 [cm]

8 [cm]

185 [kg]

185 [kg]

118 [°C]

150 [°C]

10,5 [g/s]

13,9 [g/s]



# Hera · Hera XUP! / p. 150

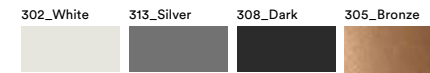
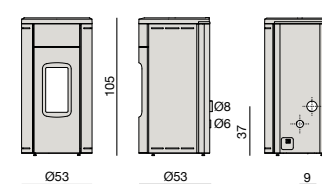

## AIR Model: HERA AIR 7 S1 / HERA AIR 7 XUP! S1

7 – 6.020 [kW-kcal/h]

2,8 – 2.408 [kW-kcal/h]

89 / 93 [%]

23 [l]

pellet Ø 6 x 3÷40 [mm]

~ 0,6 / ~ 1,67 [kg/h]

~ 26 / ~ 9 [h]

127/55 - 200/35 - 350/20 [m³] \*

8 [cm]

60 [kg]

193 [°C]

2,5 / 4,7 [g/s]



# Alea · Alea XUP! / p. 154

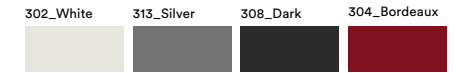
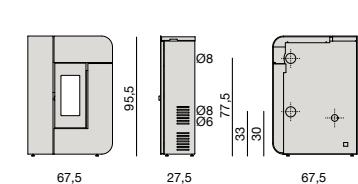

## AIR Model: ALEA AIR 7 S1

7 – 6.020 [kW-kcal/h]

2,7 – 2.322 [kW-kcal/h]

89,5 / 93 [%]

19 [l]

pellet Ø 6 x 3÷40 [mm]

~ 0,61 / ~ 1,7 [kg/h]

~ 24 / ~ 7,5 [h]

127/55 - 200/35 - 350/20 [m³] \*

8 [cm]

65 [kg]

182 [°C]

3 / 4,9 [g/s]



# Raam · Raam UP! · Raam XUP!

p. 158

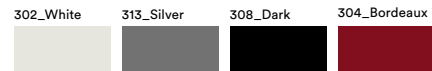
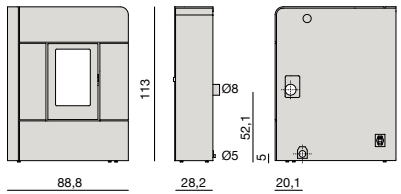

COMFORT AIR Model: RAAM COMFORT AIR 8 S1	COMFORT AIR UP! Model: RAAM COMFORT AIR 8 UP! S1
7,8 - 6.708 [kW-kcal/h]	7,8 - 6.708 [kW-kcal/h]
2,3 - 1.978 [kW-kcal/h]	2,3 - 1.978 [kW-kcal/h]
90,2 / 91,0 [%]	90,2 / 91,0 [%]
28 [l]	28 [l]
pellet Ø 6 x 3÷40 [mm]	pellet Ø 6 x 3÷40 [mm]
~ 0,5 / ~ 1,7 [kg/h]	~ 0,5 / ~ 1,7 [kg/h]
~ 36 / ~ 11 [h]	~ 36 / ~ 11 [h]
142/55 - 223/35 - 390/20 [m³] *	142/55 - 223/35 - 390/20 [m³] *
8 [cm]	8 [cm]
148 [kg]	148 [kg]
179 [°C]	179 [°C]
4,7 [g/s]	4,7 [g/s]

CE  
EN 14785  
BlmSchV Stufe 2  
ART. 15a B-VG 2015  
REGENSBURGER/  
AACHENER/  
MÜNCHENER BStV  
LRV

Conto Termico 2.0 **A+**

# Thea / p. 162

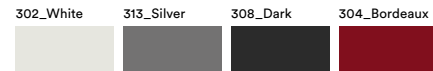
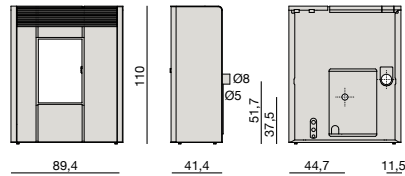

HYDRO 16 Model: THEA HYDRO 16 S1	HYDRO 24 Model: THEA HYDRO 24 S1
16,2-13.932 [kW-kcal/h] water 12,9-11.094	22,8-19.608 [kW-kcal/h] water 18,7-16.082
4,7-4.042 [kW-kcal/h] water 3,1-2.666	4,7-4.042 [kW-kcal/h] water 3,1-2.666
93,3 / 96,5 [%]	91,3 / 96,5 [%]
40 [l]	40 [l]
pellet Ø 6 x 3÷40 [mm]	pellet Ø 6 x 3÷40 [mm]
~ 1,0 / ~ 3,5 [kg/h]	~ 1,0 / ~ 5,0 [kg/h]
~ 26 / ~ 8 [h]	~ 26 / ~ 5 [h]
295/55 - 463/35 - 810/20 [m³] *	415/55 - 651/35 - 1140/20 [m³] *
8 [cm]	8 [cm]
185 [kg]	185 [kg]
118 [°C]	150 [°C]
10,5 [g/s]	13,9 [g/s]

CE  
EN 14785  
BlmSchV Stufe 2  
ART. 15a B-VG 2015  
REGENSBURGER/  
AACHENER/  
MÜNCHENER BStV  
LRV

Conto Termico 2.0 **A+**

# Sahara / p. 130

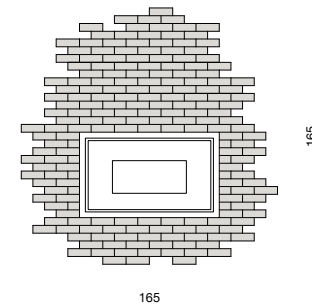

189

POWER max

POWER min



188

POWER max

POWER min





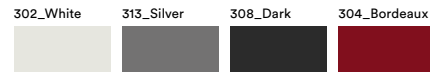
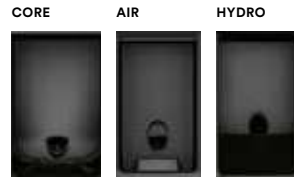
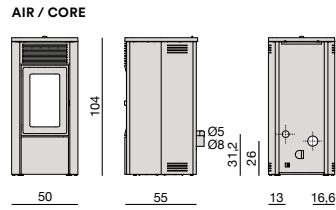
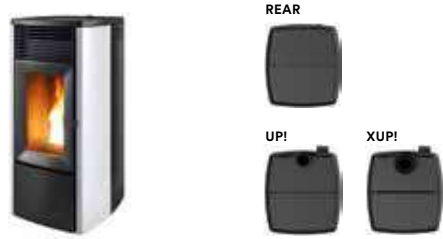

AIR	AIR UP!	AIR XUP!	CORE AIR MATIC
Model: EGO AIR 8 M2	Model: EGO AIR 8 UP! M2	Model: EGO AIR 8 XUP! M2	Model: EGO AIRMATIC 8 M3 CORE
8,1 - 6.966 [kW-kcal/h]	8,1 - 6.966 [kW-kcal/h]	8,1 - 6.966 [kW-kcal/h]	8 - 6.880 [kW-kcal/h]
2,3 - 1.978 [kW-kcal/h]	2,3 - 1.978 [kW-kcal/h]	2,3 - 1.978 [kW-kcal/h]	2,5 - 2.150 [kW-kcal/h]
90,9 / 92,6 [%]	90,9 / 92,6 [%]	90,9 / 92,6 [%]	90,4 / 92,9 [%]
38 [l]	32 [l]	32 [l]	39 [l]
pellet Ø 6 x 3÷40 [mm]	pellet Ø 6 x 3÷40 [mm]	pellet Ø 6 x 3÷40 [mm]	pellet Ø 6 x 3÷40 [mm]
~ 0,5 / ~ 1,8 [kg/h]	~ 0,5 / ~ 1,8 [kg/h]	~ 0,5 / ~ 1,8 [kg/h]	~ 0,6 / ~ 1,9 [kg/h]
~ 50 / ~ 14 [h]	~ 43 / ~ 12 [h]	~ 50 / ~ 14 [h]	~ 42 / ~ 13 [h]
147/55 - 231/35 - 405/20 [m³] *	147/55 - 231/35 - 405/20 [m³] *	147/55 - 231/35 - 405/20 [m³] *	145/55 - 229/35 - 400/20 [m³] *
8 [cm]	8 [cm]	8 [cm]	8 [cm]
127 [kg]	130 [kg]	127 [kg]	161 [kg]
188 [°C]	188 [°C]	188 [°C]	127 [°C]
4,3 [g/s]	4,3 [g/s]	4,3 [g/s]	3,1 - 5,4 [g/s]



EN 14785  
BlmSchV Stufe 2  
ART. 15a B-VG 2015  
REGENSBURGER/  
AACHENER/  
MÜNCHENER BStV  
LRV



Conto Termico 2.0  
BAFA (Hydro Matic)



(Core Air Matic)  
(Core Comfort Air Matic)

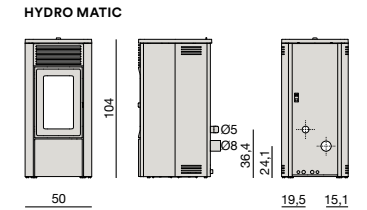
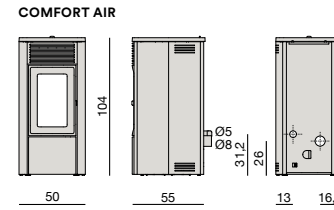

COMFORT AIR	COMFORT AIR UP!	CORE COMFORT AIR MATIC	HYDRO MATIC 12
Model: EGO COMFORT AIR 10 M2	Model: EGO COMFORT AIR 10 UP! M2	M: EGO COMFORT AIRMATIC 10 M3 CORE	Model: EGO HYDROMATIC 12 M2
10 - 8.600 [kW-kcal/h]	10 - 8.600 [kW-kcal/h]	10 - 8.600 [kW-kcal/h]	11,8-10.148 [kW-kcal/h] water 10,2-8.772
2,3 - 1.978 [kW-kcal/h]	2,3 - 1.978 [kW-kcal/h]	2,5 - 2.150 [kW-kcal/h]	3,2-2.760 [kW-kcal/h] water 2,2-1.892
90,4 / 92,6 [%]	90,4 / 92,6 [%]	90,0 / 92,9 [%]	91,8 / 92,4 [%]
38 [l]	32 [l]	39 [l]	38 [l]
pellet Ø 6 x 3÷40 [mm]	pellet Ø 6 x 3÷40 [mm]	pellet Ø 6 x 3÷40 [mm]	pellet Ø 6 x 3÷40 [mm]
~ 0,5 / ~ 2,3 [kg/h]	~ 0,5 / ~ 2,3 [kg/h]	~ 0,6 / ~ 2,3 [kg/h]	~ 0,7 / ~ 2,6 [kg/h]
~ 50 / ~ 11 [h]	~ 43 / ~ 9 [h]	~ 42 / ~ 11 [h]	~ 29 / ~ 8 [h]
182/55 - 286/35 - 500/20 [m³] *	182/55 - 286/35 - 500/20 [m³] *	182/55 - 286/35 - 500/20 [m³] *	216/55 - 340/35 - 595/20 [m³] *
8 [cm]	8 [cm]	8 [cm]	8 [cm]
130 [kg]	133 [kg]	133 [kg]	147 [kg]
212 [°C]	212 [°C]	183 [°C]	114 [°C]
5,0 [g/s]	5,0 [g/s]	3,1 - 6,4 [g/s]	9,4 [g/s]



AIR / COMFORT AIR

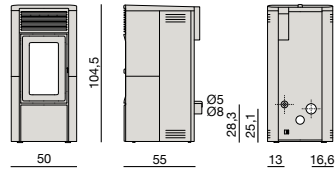

AIR HYDRO



HYDRO MATIC

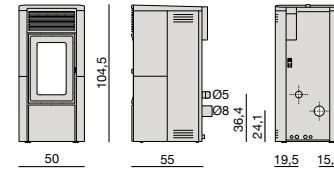

	<b>AIR</b> Model: STAR AIR 8 M2	<b>AIR UP!</b> Model: STAR AIR 8 UP! M2	<b>COMFORT AIR</b> Mod: STAR COMFORT AIR 10 M2	<b>COMFORT AIR UP!</b> Mod: STAR COMFORT AIR 10 UP! M2
<b>POWER max</b>	8,1 - 6.966 [kW-kcal/h]	8,1 - 6.966 [kW-kcal/h]	10 - 8.600 [kW-kcal/h]	10 - 8.600 [kW-kcal/h]
<b>POWER min</b>	2,3 - 1.978 [kW-kcal/h]	2,3 - 1.978 [kW-kcal/h]	2,3 - 1.978 [kW-kcal/h]	2,3 - 1.978 [kW-kcal/h]
<b>%</b>	90,9 / 92,6 [%]	90,9 / 92,6 [%]	90,4 / 92,6 [%]	90,4 / 92,6 [%]
<b>W</b>	39 [l]	33 [l]	39 [l]	33 [l]
<b>pellet</b>	pellet Ø 6 x 3÷40 [mm]	pellet Ø 6 x 3÷40 [mm]	pellet Ø 6 x 3÷40 [mm]	pellet Ø 6 x 3÷40 [mm]
<b>kg/h</b>	~ 0,5 / ~ 1,8 [kg/h]	~ 0,5 / ~ 1,8 [kg/h]	~ 0,5 / ~ 2,3 [kg/h]	~ 0,5 / ~ 2,3 [kg/h]
<b>h</b>	~ 50 / ~ 14 [h]	~ 43 / ~ 12 [h]	~ 50 / ~ 11 [h]	~ 43 / ~ 9 [h]
<b>m³</b>	147/55 - 231/35 - 405/20 [m³] *	147/55 - 231/35 - 405/20 [m³] *	182/55 - 286/35 - 500/20 [m³] *	182/55 - 286/35 - 500/20 [m³] *
<b>cm</b>	8 [cm]	8 [cm]	8 [cm]	8 [cm]
<b>kg</b>	127 [kg]	130 [kg]	130 [kg]	133 [kg]
<b>°C</b>	188 [°C]	188 [°C]	212 [°C]	212 [°C]
<b>g/s</b>	2,7 - 4,3 [g/s]	2,7 - 4,3 [g/s]	2,7 - 5,0 [g/s]	2,7 - 5,0 [g/s]

	<b>HYDRO MATIC 12</b> Model: STAR HYDROMATIC 12 M2
<b>POWER max</b>	11,9 - 10.234 [kW-kcal/h] water 10 - 8.600
<b>POWER min</b>	3,2 - 2.760 [kW-kcal/h] water 1,8 - 1.548
<b>%</b>	91,8 / 92,4 [%]
<b>W</b>	31 [l]
<b>pellet</b>	pellet Ø 6 x 3÷40 [mm]
<b>kg/h</b>	~ 0,7 / ~ 2,7 [kg/h]
<b>h</b>	~ 29 / ~ 8 [h]
<b>m³</b>	216/55 - 340/35 - 595/20 [m³] *
<b>cm</b>	8 [cm]
<b>kg</b>	147 [kg]
<b>°C</b>	123 [°C]
<b>g/s</b>	3,8 - 9,6 [g/s]



EN 14785  
BlmSchV Stufe 2  
ART. 15a B-VG 2015  
REGENSBURGER/  
AACHENER/  
MÜNCHENER BStV  
LRV





REAR

UP!

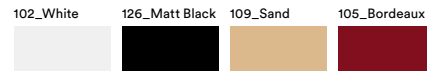
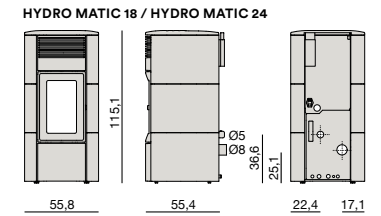
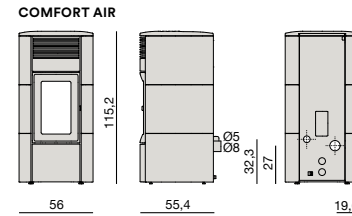
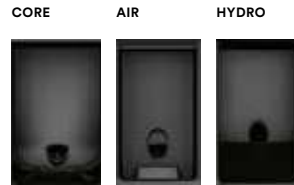
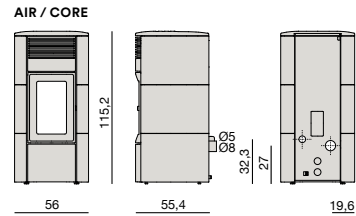

AIR	AIR UP!	CORE AIR MATIC	COMFORT AIR 12	COMFORT AIR 12 UP!	COMFORT AIR 14®	COMFORT AIR 14 UP!	COMFORT AIR MATIC 14®	HYDRO MATIC 18	HYDRO MATIC 24
Model: CLUB AIR 10 M2	Model: CLUB AIR 10 UP! M2	M: CLUB AIR MATIC 10 M3 CORE	Model: CLUB COMFORT AIR 12 M2	Model: CLUB COMFORT AIR 12 UP! M2	Model: CLUB COMFORT AIR 14 M2	M: CLUB COMFORT AIR 14 UP! M2	M: CLUB COMFORT AIR MATIC 14 M2	M: CLUB HYDROMATIC 18 M2	M: CLUB HYDROMATIC 24 M2 / 24 ACS M2
10 - 8.600 [kW-kcal/h]	10 - 8.600 [kW-kcal/h]	10 - 8.600 [kW-kcal/h]	11,9 - 10.234 [kW-kcal/h]	11,9 - 10.234 [kW-kcal/h]	13,8 - 11.868 [kW-kcal/h]	13,8 - 11.868 [kW-kcal/h]	13,9 - 11.954 [kW-kcal/h]	17,7-15.222 [kW-kcal/h] water 12,7-10.922	24,2-20.812 [kW-kcal/h] water 18,2-15.652
2,3 - 1.978 [kW-kcal/h]	2,3 - 1.978 [kW-kcal/h]	2,5 - 2.150 [kW-kcal/h]	3,4 - 2.924 [kW-kcal/h]	3,4 - 2.924 [kW-kcal/h]	3,4 - 2.924 [kW-kcal/h]	3,4 - 2.924 [kW-kcal/h]	3,6 - 2.924 [kW-kcal/h]	4,4-3.870 [kW-kcal/h] water 2,3-1.978	4,4-3.870 [kW-kcal/h] water 2,3-1.978
90,4 / 92,6 [%]	90,4 / 92,6 [%]	90,0 / 92,9 [%]	90,8 / 93,2 [%]	90,8 / 93,2 [%]	90,5 / 93,2 [%]	90,5 / 93,2 [%]	90,5 / 93,2 [%]	94,8 / 95,9 [%]	92,9 / 95,9 [%]
45 [l]	38 [l]	46 [l]	45 [l]	38 [l]	45 [l]	38 [l]	45 [l]	38 [l]	38 [l]
pellet Ø 6 x 3÷40 [mm]	pellet Ø 6 x 3÷40 [mm]	pellet Ø 6 x 3÷40 [mm]	pellet Ø 6 x 3÷40 [mm]	pellet Ø 6 x 3÷40 [mm]	pellet Ø 6 x 3÷40 [mm]	pellet Ø 6 x 3÷40 [mm]	pellet Ø 6 x 3÷40 [mm]	pellet Ø 6 x 3÷40 [mm]	pellet Ø 6 x 3÷40 [mm]
~ 0,5 / ~ 2,3 [kg/h]	~ 0,5 / ~ 2,3 [kg/h]	~ 0,6 / ~ 2,3 [kg/h]	~ 0,8 / ~ 2,7 [kg/h]	~ 0,8 / ~ 2,7 [kg/h]	~ 0,8 / ~ 3,1 [kg/h]	~ 0,8 / ~ 3,1 [kg/h]	~ 0,8 / ~ 3,1 [kg/h]	~ 1 / ~ 3,5 [kg/h]	~ 1 / ~ 5,3 [kg/h]
~ 60 / ~ 13 [h]	~ 52 / ~ 11 [h]	~ 50 / ~ 13 [h]	~ 37 / ~ 11 [h]	~ 33 / ~ 10 [h]	~ 37 / ~ 10 [h]	~ 33 / ~ 8 [h]	~ 37 / ~ 10 [h]	~ 26 / ~ 8 [h]	~ 26 / ~ 5 [h]
182/55 - 286/35 - 500/20 [m³] *	182/55 - 286/35 - 500/20 [m³] *	182/55 - 286/35 - 500/20 [m³] *	216/55 - 340/35 - 595/20 [m³] *	216/55 - 340/35 - 595/20 [m³] *	251/55 - 394/35 - 690/20 [m³] *	251/55 - 394/35 - 690/20 [m³] *	253/55 - 397/35 - 695/20 [m³] *	322/55 - 506/35 - 885/20 [m³] *	440/55 - 691/35 - 1210/20 [m³] *
8 [cm]	8 [cm]	8 [cm]	8 [cm]	8 [cm]	8 [cm]	8 [cm]	8 [cm]	8 [cm]	8 [cm]
165 [kg]	168 [kg]	165 [kg]	180 [kg]	183 [kg]	183 [kg]	186 [kg]	183 [kg]	190 [kg]	190 [kg]
212 [°C]	212 [°C]	183 [°C]	193 [°C]	193 [°C]	205 [°C]	205 [°C]	208 [°C]	118 [°C]	151 [°C]
5,0 [g/s]	5,0 [g/s]	3,1 - 6,4 [g/s]	6,4 [g/s]	6,4 [g/s]	7,1 [g/s]	7,1 [g/s]	7,0 [g/s]	9,1 [g/s]	12,5 [g/s]

CE

EN 14785  
BlmSchV Stufe 2  
ART. 15a B-VG 2015  
REGENSBURGER/  
AACHENER/  
MÜNCHENER BStV  
LRV



Conto Termico 2.0

(Core Air Matic)



Compte tenu de la puissance élevée, il est déconseillé d'utiliser le poêle sans canalisation de l'air chaud.  
— In view of its high power, use of the stove without hot air ducting is recommended against.



UZ-37  
BAFA



(Hydro Matic 18/24)

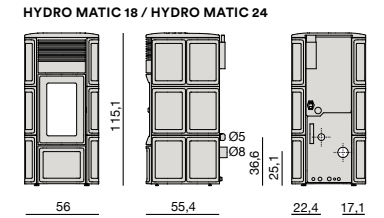
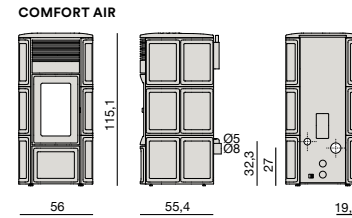
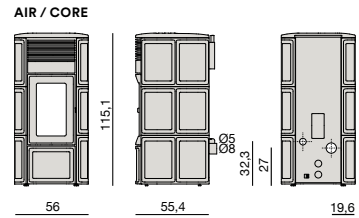

113\_Warm grey 126\_Matt Black 105\_Bordeaux 110\_Salt and pepper



AIR	AIR UP!	CORE AIR MATIC	COMFORT AIR 12	COMFORT AIR 12 UP!	COMFORT AIR 14 <sup>®</sup>	COMFORT AIR 14 UP!	COMFORT AIR MATIC 14 <sup>®</sup>	HYDRO MATIC 18	HYDRO MATIC 24
Model: SUITE AIR 10 M2	Model: SUITE AIR 10 UP! M2	M: SUITE AIR MATIC 10 M3 CORE	Model: SUITE COMFORT AIR 12 M2	Model: SUITE COMFORT AIR 12 UP! M2	Model: SUITE COMFORT AIR 14 M2	Model: SUITE COMFORT AIR 14 UP! M2	M: SUITE COMFORT AIR MATIC 14 M2	M: SUITE HYDROMATIC 18 M2	M: SUITE HYDROMATIC 24 M2/24 ACS M2
10 - 8.600 [kW-kcal/h]	10 - 8.600 [kW-kcal/h]	10 - 8.600 [kW-kcal/h]	11,9 - 10.234 [kW-kcal/h]	11,9 - 10.234 [kW-kcal/h]	13,8 - 11.868 [kW-kcal/h]	13,8 - 11.868 [kW-kcal/h]	13,9 - 11.954 [kW-kcal/h]	17,7-15.222 [kW-kcal/h] water 12,7-10.922	24,2-20.812 [kW-kcal/h] water 18,2-15.652
2,3 - 1.978 [kW-kcal/h]	2,3 - 1.978 [kW-kcal/h]	2,5 - 2.150 [kW-kcal/h]	3,4 - 2.924 [kW-kcal/h]	3,4 - 2.924 [kW-kcal/h]	3,4 - 2.924 [kW-kcal/h]	3,4 - 2.924 [kW-kcal/h]	3,6 - 2.924 [kW-kcal/h]	4,4-3.870 [kW-kcal/h] water 2,3-1.978	4,4-3.870 [kW-kcal/h] water 2,3-1.978
90,4 / 92,6 [%]	90,4 / 92,6 [%]	90,0 / 92,9 [%]	90,8 / 93,2 [%]	90,8 / 93,2 [%]	90,5 / 93,2 [%]	90,5 / 93,2 [%]	90,5 / 93,2 [%]	94,8 / 95,9 [%]	92,9 / 95,9 [%]
45 [l]	38 [l]	46 [l]	45 [l]	38 [l]	45 [l]	38 [l]	45 [l]	38 [l]	38 [l]
pellet Ø 6 x 3÷40 [mm]	pellet Ø 6 x 3÷40 [mm]	pellet Ø 6 x 3÷40 [mm]	pellet Ø 6 x 3÷40 [mm]	pellet Ø 6 x 3÷40 [mm]	pellet Ø 6 x 3÷40 [mm]	pellet Ø 6 x 3÷40 [mm]	pellet Ø 6 x 3÷40 [mm]	pellet Ø 6 x 3÷40 [mm]	pellet Ø 6 x 3÷40 [mm]
~ 0,5 / ~ 2,3 [kg/h]	~ 0,5 / ~ 2,3 [kg/h]	~ 0,6 / ~ 2,3 [kg/h]	~ 0,8 / ~ 2,7 [kg/h]	~ 0,8 / ~ 2,7 [kg/h]	~ 0,8 / ~ 3,1 [kg/h]	~ 0,8 / ~ 3,1 [kg/h]	~ 0,8 / ~ 3,1 [kg/h]	~ 1 / ~ 3,5 [kg/h]	~ 1 / ~ 5,3 [kg/h]
~ 60 / ~ 13 [h]	~ 52 / ~ 11 [h]	~ 50 / ~ 13 [h]	~ 37 / ~ 11 [h]	~ 33 / ~ 10 [h]	~ 37 / ~ 10 [h]	~ 33 / ~ 8 [h]	~ 37 / ~ 10 [h]	~ 26 / ~ 8 [h]	~ 26 / ~ 5 [h]
182/55 - 286/35 - 500/20 [m³] *	182/55 - 286/35 - 500/20 [m³] *	182/55 - 286/35 - 500/20 [m³] *	216/55 - 340/35 - 595/20 [m³] *	216/55 - 340/35 - 595/20 [m³] *	251/55 - 394/35 - 690/20 [m³] *	251/55 - 394/35 - 690/20 [m³] *	253/55 - 397/35 - 695/20 [m³] *	322/55 - 506/35 - 885/20 [m³] *	440/55 - 691/35 - 1210/20 [m³] *
8 [cm]	8 [cm]	8 [cm]	8 [cm]	8 [cm]	8 [cm]	8 [cm]	8 [cm]	8 [cm]	8 [cm]
165 [kg]	168 [kg]	165 [kg]	180 [kg]	183 [kg]	183 [kg]	186 [kg]	183 [kg]	190 [kg]	190 [kg]
212 [°C]	212 [°C]	183 [°C]	193 [°C]	193 [°C]	205 [°C]	205 [°C]	208 [°C]	118 [°C]	151 [°C]
5,0 [g/s]	5,0 [g/s]	3,1 - 6,4 [g/s]	6,4 [g/s]	6,4 [g/s]	7,1 [g/s]	7,1 [g/s]	7,0 [g/s]	9,1 [g/s]	12,5 [g/s]

CE

EN 14785  
BlmSchV Stufe 2  
ART. 15a B-VG 2015  
REGENSBURGER/  
AACHENER/  
MÜNCHENER BStV  
LRV



⊕

Compte tenu de la puissance élevée, il est déconseillé d'utiliser le poêle sans canalisation de l'air chaud.  
— In view of its high power, use of the stove without hot air ducting is recommended against.



UZ-37  
BAFA  
(Hydro Matic 18/24)



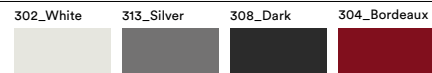
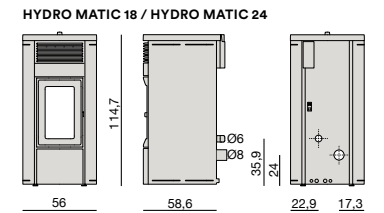
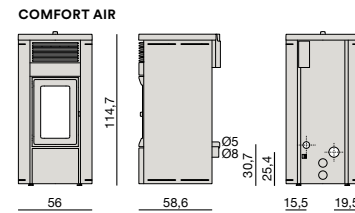
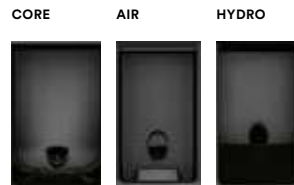
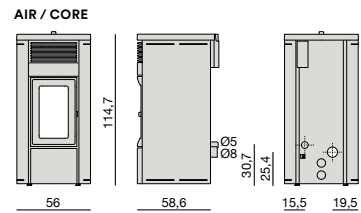

AIR	AIR UP!	CORE AIR MATIC	COMFORT AIR 12	COMFORT AIR 12 UP!	COMFORT AIR 14®	COMFORT AIR 14 UP!®	COMFORT AIR MATIC 14	HYDRO MATIC 18	HYDRO MATIC 24
Model: MUSA AIR 10 M2	Model: MUSA AIR 10 UP! M2	M: MUSA AIRMATIC 10 M3 CORE	M: MUSA COMFORT AIR 12 M2	M: MUSA COMFORT AIR 12 UP! M2	M: MUSA COMFORT AIR 14 M2	M: MUSA C. AIR 14 UP! M2	M: MUSA C. AIR MATIC 14 M2	M: MUSA HYDROMATIC 18 M2	M: MUSA HYDROMATIC 24 M2
10 - 8.600 [kW-kcal/h]	10 - 8.600 [kW-kcal/h]	10 - 8.600 [kW-kcal/h]	11,9 - 10.234 [kW-kcal/h]	11,9 - 10.234 [kW-kcal/h]	13,8 - 11.868 [kW-kcal/h]	13,8 - 11.868 [kW-kcal/h]	13,9 - 11.954 [kW-kcal/h]	17,7 - 15.222 [kW-kcal/h] water 12,7 - 10.922	24,2 - 20.812 [kW-kcal/h] water 18,2-15.652
2,3 - 1.978 [kW-kcal/h]	2,3 - 1.978 [kW-kcal/h]	2,5 - 2.150 [kW-kcal/h]	3,4 - 2.924 [kW-kcal/h]	3,4 - 2.924 [kW-kcal/h]	3,4 - 2.924 [kW-kcal/h]	3,4 - 2.924 [kW-kcal/h]	3,7 - 3.182 [kW-kcal/h]	4,4 - 3.784 [kW-kcal/h] water 2,3 - 1.978	4,4 - 3.784 [kW-kcal/h] water 2,3 - 1.978
90,4 / 92,6 [%]	90,4 / 92,6 [%]	90,0 / 92,9 [%]	90,8 / 93,2 [%]	90,8 / 93,2 [%]	90,5 / 93,2 [%]	90,5 / 93,2 [%]	90,2 / 92,3 [%]	94,8 / 95,9 [%]	92,9 / 95,9 [%]
46 [l]	40 [l]	46 [l]	46 [l]	40 [l]	46 [l]	40 [l]	46 [l]	40 [l]	40 [l]
pellet Ø 6 x 3÷40 [mm]	pellet Ø 6 x 3÷40 [mm]	pellet Ø 6 x 3÷40 [mm]	pellet Ø 6 x 3÷40 [mm]	pellet Ø 6 x 3÷40 [mm]	pellet Ø 6 x 3÷40 [mm]	pellet Ø 6 x 3÷40 [mm]	pellet Ø 6 x 3÷40 [mm]	pellet Ø 6 x 3÷40 [mm]	pellet Ø 6 x 3÷40 [mm]
~ 0,5 / ~ 2,3 [kg/h]	~ 0,5 / ~ 2,3 [kg/h]	~ 0,6 / ~ 2,3 [kg/h]	~ 0,8 / ~ 2,7 [kg/h]	~ 0,8 / ~ 2,7 [kg/h]	~ 0,8 / ~ 3,1 [kg/h]	~ 0,8 / ~ 3,1 [kg/h]	~ 0,8 / ~ 3,1 [kg/h]	~ 1 / ~ 3,9 [kg/h]	~ 1 / ~ 5,4 [kg/h]
~ 60 / ~ 13 [h]	~ 52 / ~ 11 [h]	~ 50 / ~ 13 [h]	~ 37 / ~ 11 [h]	~ 33 / ~ 10 [h]	~ 37 / ~ 10 [h]	~ 33 / ~ 8 [h]	~ 37 / ~ 10 [h]	~ 25 / ~ 7 [h]	~ 25 / ~ 5 [h]
182/55 - 286/35 - 500/20 [m³] *	182/55 - 286/35 - 500/20 [m³] *	182/55 - 286/35 - 500/20 [m³] *	216/55 - 340/35 - 595/20 [m³] *	216/55 - 340/35 - 595/20 [m³] *	251/55 - 394/35 - 690/20 [m³] *	251/55 - 394/35 - 690/20 [m³] *	253/55 - 397/35 - 695/20 [m³] *	322/55 - 506/35 - 885/20 [m³] *	440/55 - 691/35 - 1210/20 [m³] *
8 [cm]	8 [cm]	8 [cm]	8 [cm]	8 [cm]	8 [cm]	8 [cm]	8 [cm]	8 [cm]	8 [cm]
165 [kg]	168 [kg]	165 [kg]	180 [kg]	183 [kg]	183 [kg]	186 [kg]	183 [kg]	190 [kg]	190 [kg]
212 [°C]	212 [°C]	183 [°C]	193 [°C]	193 [°C]	205 [°C]	205 [°C]	208 [°C]	107 [°C]	143 [°C]
2,7 - 5,0 [g/s]	2,7 - 5,0 [g/s]	3,1 - 6,4 [g/s]	3,1 - 6,4 [g/s]	3,1 - 6,4 [g/s]	3,1 - 7,1 [g/s]	3,1 - 7,1 [g/s]	3,3 - 7,0 [g/s]	5,4 - 10,6 [g/s]	5,4 - 14,2 [g/s]

CE  
EN 14785  
BlmSchV Stufe 2  
ART. 15a B-VG 2015  
REGENSBURGER/  
AACHENER/  
MÜNCHENER BStV  
LRV



UZ-37  
BAFA  
(Hydro Matic 18/24)

⊕  
Compte tenu de la puissance élevée, il est déconseillé d'utiliser le poêle sans canalisation de l'air chaud.  
— In view of its high power, use of the stove without hot air ducting is recommended against.



	air	comfort air	comfort air	hydro	oyster	quick start	no air	brush less	matic					kit wifi				maestro	maestro'	core	
p.176	●	●			●	●	●	●		●	●	●	○					●			Mood
p.177	●				●	●	●	●		●	●	●	○					●			Halo
p.177	●				●	●	●	●		●	●	●	○					●			Halo UP!
p.178	●	●			●	●	●	●		●	●	●	○					●			Flow Comfort Air 10
p.174	●	●			●	●	●	●	●	●	●	●	○					●		●	Mako <span style="color:red">NEW</span>
p.178	●				●	●	●	●		●	●	●	○					●			Reflex UP!
p.179	●				●	●	●	●		●	●	●	○					●			Doc
p.179	●				●	●	●	●		●	●	●	○					●			Doc UP!
p.180	●				●	●	●	●		●	●	●	○					●			Stream
p.180	●				●	●	●	●		●	●	●	○					●			Stream UP!
p.181	●			●	●	●	●	●	●	●	●	●	○					●			AkiHydro Matic 16
p.181	●			●	●	●	●	●	●	●	●	●	○					●			AkiHydro Matic 16 UP!
p.181	●			●	●	●	●	●	●	●	●	●	○					●			AkiHydro Matic 24
p.181	●			●	●	●	●	●	●	●	●	●	○					●			AkiHydro Matic 24 UP!
p.179	●	●			●	●	●	●		●	●	●	○					●			Ray
p.179	●	●			●	●	●	●		●	●	●	○					●			Ray UP!
p.179	●	●			●	●	●	●		●	●	●	○					●			Ray XUP!
p.180	●				●	●	●	●		●	●	●	○					●			Philo 14
p.180	●				●	●	●	●		●	●	●	○					●			Philo 14 UP!
p.183	●				●	●	●	●		●	●	●	○					●			Decò
p.184	●				●	●	●	●		●	●	●	○					●			Cute
p.182	●				●	●	●	●		●	●	●	○					●			Tecla
p.181	●				●	●	●	●		●	●	●	○					●			Alyssa
p.183	●				●	●	●	●	●	●	●	●	○					●			Jazz













● Standard ○ Optional

	Alea Air	Alea Air XUP!	Raam	Raam UP!	Raam XUP!	Thea Hydro 16	Thea Hydro 16 UP!	Thea Hydro 23	Thea Hydro 23 UP!	Ghea <span style="color:red">NEW</span>	Ghea XUP! <span style="color:red">NEW</span>	Mida <span style="color:red">NEW</span>	Mida XUP! <span style="color:red">NEW</span>	Teia <span style="color:red">NEW</span>	Teia UP! <span style="color:red">NEW</span>	May	Hera Air	Hera Air XUP!	Clio 16	Clio 23		Vivo Maestro 90 Comfor Air 9	Vivo Maestro 90 Comfor Air 11	Vivo Maestro 90 Hydro 16	Vivo Maestro 90 Hydro 24	Boxtherm Maestro 60	Boxtherm Maestro 70		
p.187	●	●																											
p.187	●	●																											
p.188			●	●	●																								
p.188			●	●	●																								
p.188			●	●	●																								
p.188			●	●	●																								
p.185	●	●								●	●	●	●	●	●	●													
p.185	●	●								●	●	●	●	●	●	●													
p.185	●	●								●	●	●	●	●	●	●													
p.185	●	●								●	●	●	●	●	●	●													
p.186	●	●								●	●	●	●	●	●	●													
p.186	●	●								●	●	●	●	●	●	●													
p.184																○													
p.187																○													
p.187																○													
p.186																○													
p.186																○													
p.169																							●						
p.169																							●	±					
p.171																								●					
p.171																								●					
p.173																								●					
p.173																								●					

● Standard ○ Optional

# Légende / Key

204























	Puissance thermique utile max [kW-kcal/h]	Nominal heat output [kW-kcal/h]
	Puissance thermique utile min [kW-kcal/h]	Reduced heat output [kW-kcal/h]
	Rendement au max / au min [%]	Efficiency at max / at min [%]
	Capacité du réservoir [l]	Hopper capacity [l]
	Type de combustible	Fuel type
	Consommation horaire (min/max) [kg/h]	Hourly consumption (min/max) [kg/h]
	Autonomie (au min/au max) [h]	Runtime (at min/at max)[h]
	Volume de chauffe [m <sup>3</sup> ] *	Heatable volume [m <sup>3</sup> ] *
	Diamètre de sortie des fumées [cm]	Diameter of smoke outlet pipe [cm]
	Poids [kg]	Weight [kg]
	Température des fumées [°C]	Smoke temperature [°C]
	Débit massique des fumées [g/s]	Massive smoke capacity [g/s]

\*  
 \_ Volume maximum chauffable selon la puissance requise par m<sup>3</sup>  
 (respectivement 55-35-20 W par m<sup>3</sup>)  
 \_ Maximum heatable volume based on the power required per m<sup>3</sup>  
 (respectively 55-35-20 W per m<sup>3</sup>)



Compte tenu de la puissance élevée, il est déconseillé d'utiliser le poêle sans canalisation de l'air chaud.  
 — In view of its high power, use of the stove without hot air ducting is recommended against.

205

	Ventilation forcée	Forced ventilation
	Air canalisée : une canalisation	Ducted air: one air duct
	Air canalisée : deux canalisations	Ducted air: two air ducts
	Eau	Water
	Oyster	Oyster
	Allumage en 3 minutes	Ignition in 3 minutes
	Ventilation désactivable	Excludable ventilation
	Brushless	Brushless
	Matic	Matic
	Vidage des cendres hebdomadaire	Weekly ash emptying
	Récupération des conduits de fumée existants	Use of existing flues
	Conduit d'évacuation de fumées coaxial	Coaxial smoke outlet
	Aucun bruit	Noise-free
	Kit X-Up	Kit X-Up
	Kit Wi-fi	Kit Wi-fi
	Double Wi-fi	Double Wi-fi
	Panneau	Panel
	Télècommande avec thermostat ambiance	Remote control with room thermostat
	Smartphone	Smartphone
	Maestro	Maestro
	Maestro+	Maestro+
	Technologie « CORE » brevetée	Patented "CORE" technology



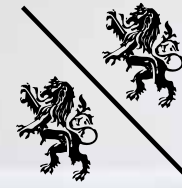

**SERGIOLEONI**

206

207



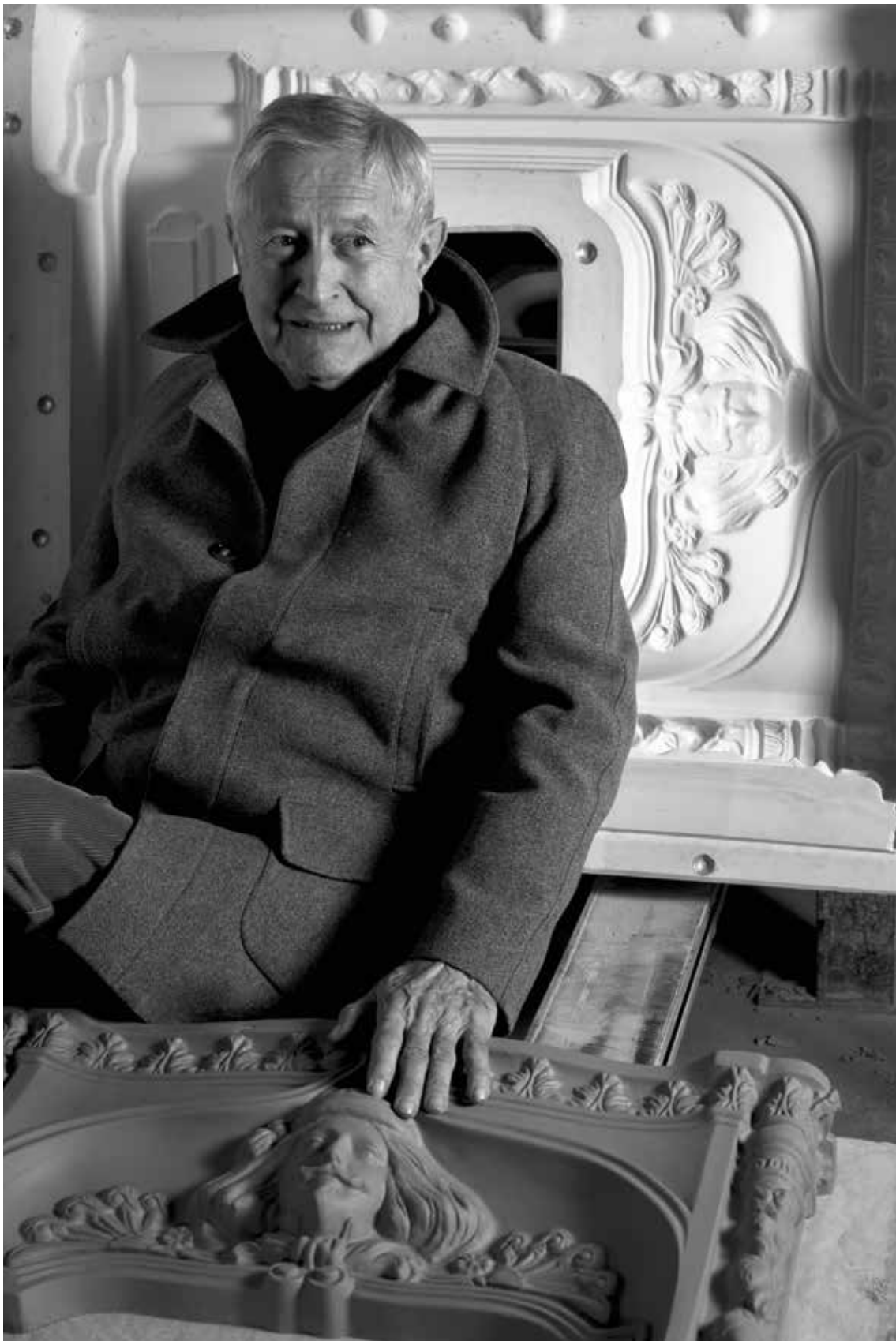

Dans la culture italienne, souvent les figures de l'artiste et de l'artisan coïncident parfaitement, comme les deux moitiés d'un moule.

L'histoire de Sergio Leoni est, à cet égard, exemplaire: après ses premières études dans le domaine du dessin artistique, de la sculpture et du modelage de l'argile, débutées dès son plus jeune âge il y a plus de 50 ans, le maître a consacré son travail à la production artisanale, en alliant sa recherche stylistique au monde des poêles, à leur identité en tant qu'objets d'art et à la qualité de leur chaleur.

Dans le laboratoire de Sergio Leoni, chaque poêle est réalisé à main avec des matériaux et des éléments naturels, tels que l'argile, l'eau et le feu : les temps de production dépendent de leur combinaison.

Tout le reste, comme Sergio Leoni le répète toujours, c'est du métier, de l'humilité pour écouter et de la patience pour essayer.

Le résultat est une collection de poêles artistiques, conçus pour durer au fil des années, suscitant le bien-être inimitable de leur chaleur et l'émotion unique de leur beauté, dans les palais, châteaux, demeures antiques ou modernes du monde entier.

— Eng — In Italian culture, the characters of artist and craftsman often coincide perfectly, as do the two halves of a mould. The story of Sergio Leoni is exemplary in this sense: since completing his early studies in artistic drawing, sculpture and clay modelling – which he began as a boy over 50 years ago – the Maestro has devoted his creativity and stylistic research to the crafting of stoves, their artistic character and heating quality. In Sergio Leoni's workshop each stove is made by hand, using natural elements and materials – such as clay, water

and fire – a combination of which determines the rhythm of production. All the rest is a matter of having the necessary craftsmanship, humility to listen and patience to experiment, as Sergio Leoni is always saying. The result is a collection of artistic wood stoves, made to last forever, irradiating inimitable well-being with their warmth, and arousing equally unmatched emotion with their beauty in palaces, castles, and in ancient and modern homes throughout the world.

## MARIA COSTANZA

Poêle à pellets de profondeur réduite avec habillage en céramique artisanale qui réinterprète dans un style moderne le design des anciens poêles nordiques. Porte en fonte et couvercle en acier peint noir. Ventilation forcée et structure étanche. Ce poêle est déjà conforme à la norme Ecodesign 2022. Vous avez de série, la possibilité de commander le poêle via Wi-Fi avec le système easy Connect (de série).

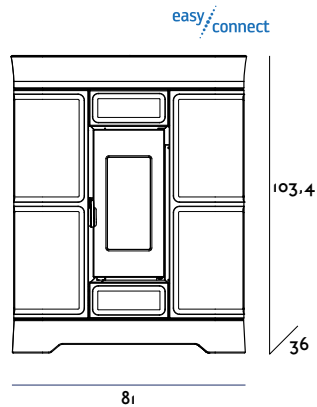

— Eng — Slim pellet stove with handcrafted ceramic cladding that reinterprets the design of old Nordic stoves with a modern twist. Cast iron door and Black painted steel top. Forced ventilation and sealed structure. This

stove is already compliant with the Ecodesign 2022 regulation. Easy Connect system stove control option as standard.

### MARIA COSTANZA

Model: MARIA COSTANZA P/V 7 SI



Puissance thermique utile max  
Nominal heat output

7 kW

Puissance thermique utile min  
Reduced heat output

2,7 kW

Rendement  
Efficiency

89,6/93,1%



## REGINA

Poêle à pellets à ventilation forcée avec habillage en céramique artisanale qui réinterprète dans un style moderne le design des anciens poêles nordiques. Porte en fonte et couvercle en acier peint noir. Structure étanche. Ce poêle est déjà conforme à la norme Ecodesign 2022. Vous avez de série, la possibilité de commander le poêle via Wi-Fi avec le système easy Connect (de série).

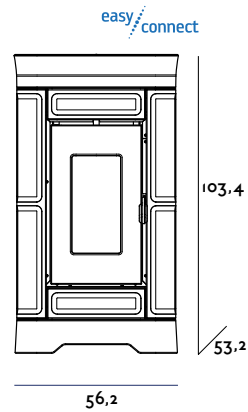

— Eng — Forced-ventilation pellet stove with handcrafted ceramic cladding that reinterprets the design of old Nordic stoves with a modern twist. Cast iron door

and Black painted steel top. Sealed structure. This stove is already compliant with the Ecodesign 2022 regulation. Easy Connect system stove control option as standard.

### **REGINA**

Model: REGINA P/V 7 SI



Puissance thermique utile max  
Nominal heat output

7 kW

Puissance thermique utile min  
Reduced heat output

2,5 kW

Rendement  
Efficiency

90,5/95,0%



## MARIA SOFIA

Poêle à pellets ventilé. Naît le style classique contemporain, dans lequel la recherche des formes classiques de Sergio Leoni est exprimée de manière plus sobre. En essayant d'entrer dans des contextes plus contemporains, la décoration traditionnelle est devenue un traitement de la surface, qui, grâce à l'effet de la lumière, rappelle un bijou. La technologie Maestro permet au poêle d'exprimer son plus grand potentiel, avec un usage encore plus facile et convivial. Un véritable micro-ordinateur communique avec votre smartphone, améliorant davantage le rendement du poêle. Ce poêle est déjà conforme à la norme Ecodesign 2022.

Télécommande freestanding avec thermostat d'ambiance (en option).

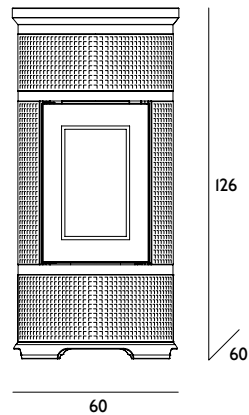

— Eng — Ventilated pellet stove. Classic contemporary style is born, in which elegant classical shapes by Sergio Leoni are expressed in a more simple way. For application in more contemporary settings, traditional decoration has now become surface treatment, which, thanks to lighting effects, resembles a jewel. Maestro technology allows the heater to express its utmost

potential with even an easier and more intuitive use. A real integrated micro-computer dialogues with your smartphone and further improve the performances of the heater. This stove is already compliant with the Ecodesign 2022 regulation. Freestanding remote control with room thermostat (optional).

### MARIA SOFIA [P/V]

Model: MARLENE TONDA P/V 8 MI



Puissance thermique utile max  
Nominal heat output

8,1 kW

Puissance thermique utile min  
Reduced heat output

2,3 kW

Rendement  
Efficiency

90,9/92,6%



## MARLENE

L'exclusivité de la céramique artistique Sergio Leoni, la facilité d'utilisation et la capacité de programmation maximale d'un produit à pellet sont les précieuses caractéristiques de Marlene, désormais disponible également dans une nouvelle version à air canalisable à haute puissance (10 kW) avec sortie supérieure des fumées. Marlene est déjà conforme à la norme Ecodesign 2022. Télécommande freestanding avec thermostat d'ambiance (en option).

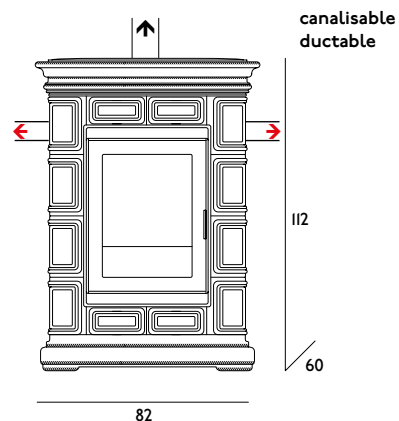

— Eng — The exclusivity of the ceramic art of Sergio Leoni, easy use and maximum programmability of a pellet product are the precious characteristics of Marlene, now also available in a new ducted-air, high

power (10 kW) version with top smoke outlet. Marlene is already compliant with the Ecodesign 2022 regulation. Freestanding remote control with room thermostat (optional).

### MARLENE SS [P/C]

Model: MARLENE PC 10 SS MI

A+

Puissance thermique utile max  
Nominal heat output

10 kW

Puissance thermique utile min  
Reduced heat output

2,3 kW

Rendement  
Efficiency

90,4/92,6%



## MARLENE TONDA

Naît le style classique contemporain, dans lequel la recherche des formes classiques de Sergio Leoni est exprimée de manière plus sobre. Ce poêle est déjà conforme à la norme Ecodesign 2022. Télécommande « freestanding » avec thermostat d'ambiance (en option).

218

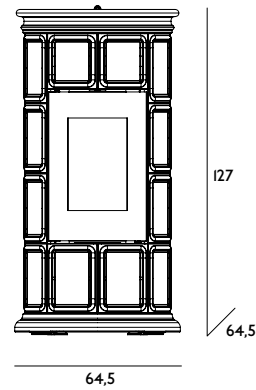

— Eng — Classic contemporary style is born, in which elegant classical shapes by Sergio Leoni are expressed in a more simple way. This stove is already compliant

with the Ecodesign 2022 regulation. Freestanding remote control with room thermostat (optional).

**MARLENE TONDA** [P/V]  
Model: MARLENE TONDA P/V 8 MI

**A+** **maestro**

Puissance thermique utile max  
Nominal heat output

**8,1 kW**

Puissance thermique utile min  
Reduced heat output

**2,3 kW**

Rendement  
Efficiency

**90,9/92,6%**



219

## SISSY

L'elegance de la décoration, l'austérité des lignes, la facilité d'utilisation et la capacité de programmation maximale d'un produit à pellet sont les caractéristiques de Sissy, désormais disponible également dans une nouvelle version à air canalisable à haute puissance (10 kW) avec sortie supérieure des fumées. Sissy est déjà conforme à la norme Ecodesign 2022.

Télécommande freestanding avec thermostat d'ambiance (en option).

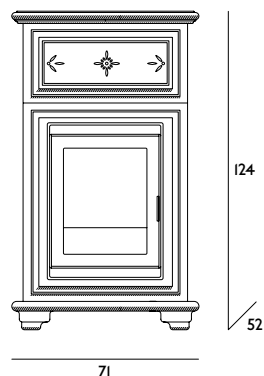

— Eng — The preciousness of the decor, the austerity of the lines, easy use and maximum programmability of a pellet product are the characteristics of Sissy, now also available in a new ducted-air, high power (10 kW) version

with top smoke outlet. Sissy is already compliant with the Ecodesign 2022 regulation. Freestanding remote control with room thermostat (optional).

### SISSY [P/C]

Model: SISSY PELLETT PC 10 SS MI

A+

Puissance thermique utile max  
Nominal heat output

10 kW

Puissance thermique utile min  
Reduced heat output

2,3 kW

Rendement  
Efficiency

90,4/92,6%





# QUELLE EST LA PREMIÈRE ÉNERGIE RENEUVABLE ? — WHICH IS THE FIRST RENEWABLE ENERGY?

222



FR — Le bois est absolument la première source d'énergie renouvelable dans le monde, et plus encore en Europe.

Vous ne le saviez pas ? Ne vous sentez pas coupable, car presque personne ne le sait. Nous savons tous en revanche que les énergies renouvelables sont essentielles pour lutter contre les émissions de CO<sup>2</sup> et donc contre le réchauffement climatique.

EN — Worldwide, and even more so in Europe, wood is unquestionably the first among renewable energies.

Did you not know? Well, don't feel bad about it, because practically no-one knows. On the contrary, everybody knows that renewable energies are essential to counter CO<sup>2</sup> emissions, hence global warming.

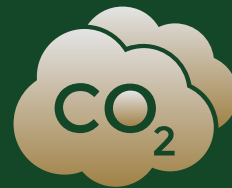

MCZ PELLET

# QUELS SONT LES AVANTAGES DU BOIS ? — WHAT ARE THE ADVANTAGES OF WOOD?

223



Il s'agit de la première énergie renouvelable au monde.  
It is the first renewable energy in the world.



Il vous permet de faire des économies sur votre facture par rapport aux sources d'énergie fossiles.  
It makes for lower bills compared to fossil fuels.

Il crée des entreprises et des emplois dans notre pays.  
It generates business and employment in our country.



Il met en valeur et protège notre patrimoine forestier.  
It uses our forestry heritage while protecting it.

Il lutte contre l'effet de serre avec les autres énergies renouvelables.  
Together with other renewable energies, it counters the greenhouse effect.



Il fait partie des secteurs qu'investissent le plus dans les nouvelles technologies.  
It is one of the sectors with the largest investments in new technologies.

À ce jour, les nouveaux appareils réduisent déjà les émissions jusqu'à 80 % par rapport aux anciens générateurs de chaleur.  
Already today, the new appliances reduce emissions up to 80% compared to old heat generators.

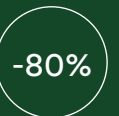

EU

Il contribue à respecter les normes européennes en matière d'énergies renouvelables.  
It contributes to complying with European standards on renewable energies.

MCZ PELLET



MCZ Group Spa  
Via La Croce, 8  
33074 Fontanafredda  
Pordenone, Italia  
[www.mcz.it](http://www.mcz.it)  
[www.mczgroup.it](http://www.mczgroup.it)

L'Entreprise se réserve le droit de modifier les caractéristiques techniques et esthétiques des produits sans préavis.  
The Company reserves the right to change the technical and aesthetic features of the products without prior notice.